

# Some Housekeeping Items



- Listen through your computer
  - Please select the “mic and speakers” radio button on the right-hand audio and pane display
- Technical Difficulties
  - Contact the Go To Webinars Help Desk: 888-259-3826
- To ask a question
  - Select the “Questions” pane on your screen and type in your question
- Share with others or watch it again
  - A video/audio recording of the webinar and the slide decks will be made available at [www.gen-4.org](http://www.gen-4.org)
- Please take the survey at: <https://www.surveymonkey.com/r/P95YNXM>.



# FORMULATION OF ALTERNATIVE CEMENT MATRIX FOR SOLIDIFICATION/STABILIZATION OF NUCLEAR WASTE

Mr. Matthieu De Campos, PhD student  
Lille University, France  
May 22, 2019



Supervisors: Prof. C. A. Davy (Centrale Lille), Dr M. Rivenet (ENSCL), UCCS UMR CNRS 8181 and J. Garcia (Orano)



# Meet the Presenter



Mr. **Matthieu De Campos** is a second year PhD student at the University of Lille, within the Solid Chemistry axis of the UCCS laboratory (Catalysis and Solid Chemistry Unit). He is a member of the research team CIMEND (“Chimie, Matériaux Et procédés pour un Nucléaire Durable” i.e. “Chemistry, Materials and Processes for Sustainable Nuclear Activities”). This research team is involved in a joint laboratory between the University of Lille and Orano, the Laboratoire de Recherche Commun Cycle du Combustible et Chimie de l’Uranium (LR4CU) (for Joint Research Laboratory on Fuel and Uranium Chemistry).

The LR4CU is focused on generating added value to fuel cycle by-products and optimizing nuclear processes. The aim is to increase the TRL levels for futures industrial applications. His PhD research aims at adding value to low-radioactive metallic materials, by considering them as reagents for the synthesis of cementitious matrix. His research activities, funded by Orano, are based on a multidisciplinary approach combining Civil Engineering and Solid State Chemistry. In 2017, he graduated from Artois University with a Masters’ Degree in Materials Chemistry for Energy and the Environment.

As one of three students to win the Elevator Pitch Challenge (EPiC) contest during the October 2018 GIF Symposium meeting in Paris, Mr. Campos has been awarded the opportunity to give this presentation.

Email: [Matthieu.De-Campos@univ-lille.fr](mailto:Matthieu.De-Campos@univ-lille.fr)



# Outline

- Nuclear waste ?
  - Nuclear waste management
  - French nuclear system & waste management
  - Dismantling challenge
- Difference between MKP & OPC
  - Stabilization/solidification
  - MKP cement
  - OPC cement
- PhD work
  - Key points
  - Tests miniaturization
  - Conclusion



# Nuclear Waste Management

## ■ Nuclear waste?

It is any material, without any use, which contains radionuclides in higher concentrations than the values considered admissible (by the competent authority) for such materials (International Atomic Energy Agency, IAEA)

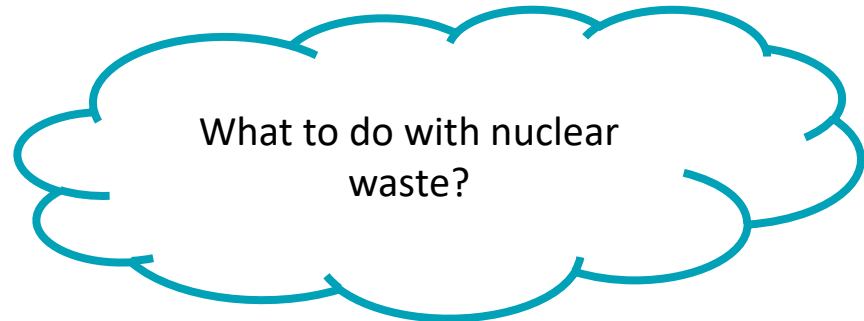
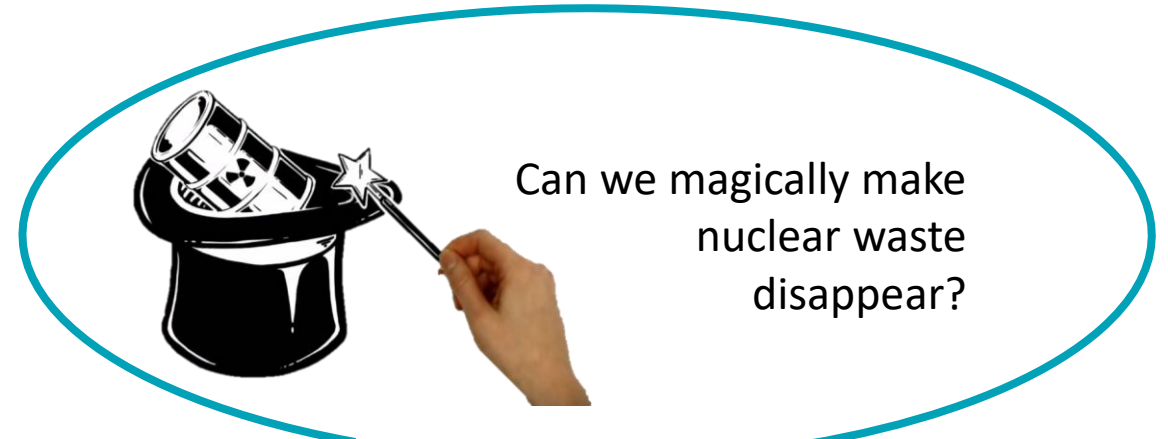









# What to do with Nuclear Waste ?

- ✓ Classify waste according to their level of radioactivity
- ✓ Managing waste according to the half-life time of radioelements
- ✓ Create processing channels based on this information :
  - Radioactive decay management
  - Surface storage
  - Deep storage
- ✓ How to store them safely?



# French Classification of Nuclear Waste

Firstly, they must be categorized!

Category	Very short-lived waste	Short-lived waste	Long-lived waste
Very low-level waste (VLLW)	 Management through radioactive decay	 Surface disposal (Industrial facility for grouping, storage and disposal)	 Near-surface disposal under development   Deep geological repository at the project phase   HLW
Low-level waste (LLW)		 Surface disposal (Aube and Manche disposal facilities)	
Intermediate-level waste (ILW)			
High-level waste (HLW)	Not applicable		

ANDRA. National Inventory of Radioactive Materials and Waste. 2018.

→ Separation of nuclear waste into 6 categories

# Volume & Radioactivity Level of Nuclear Waste

Volume & radioactivity distribution of nuclear waste

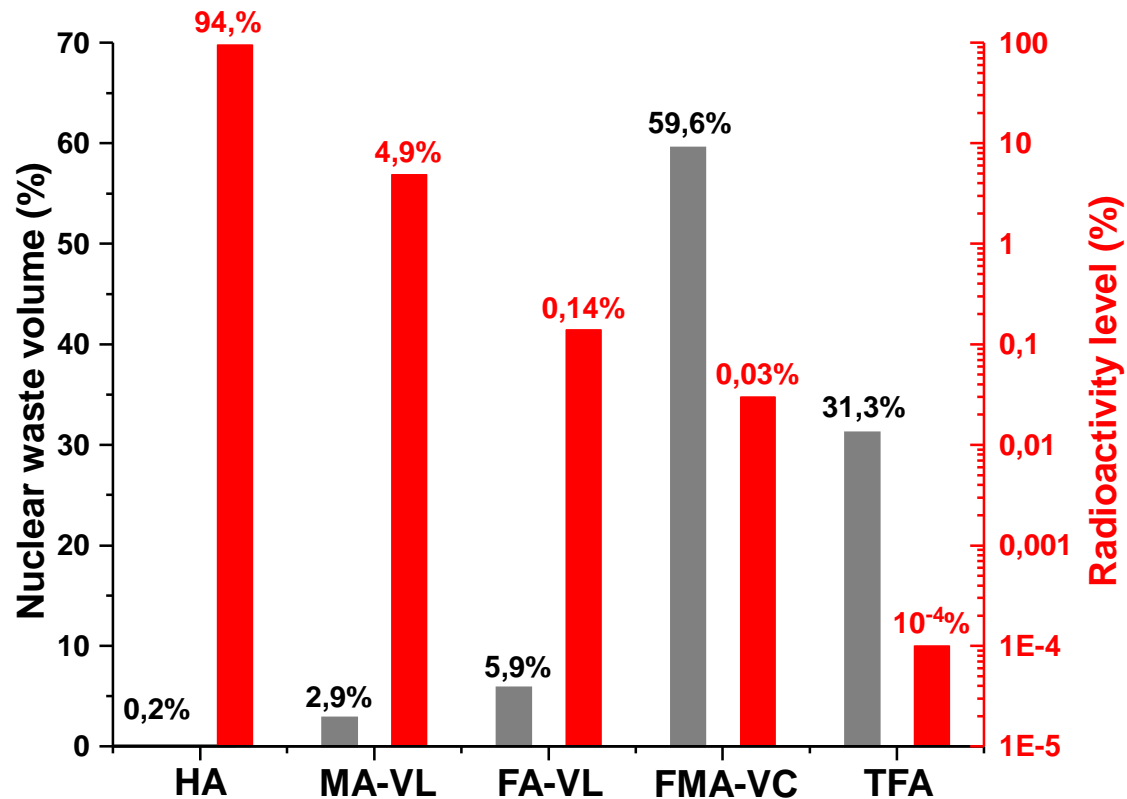

Manage each type of waste by :

- Implementing specific solutions adapted to the hazard
- Developing specific solutions adapted to the hazard
- Adapting the solutions to their evolution over time

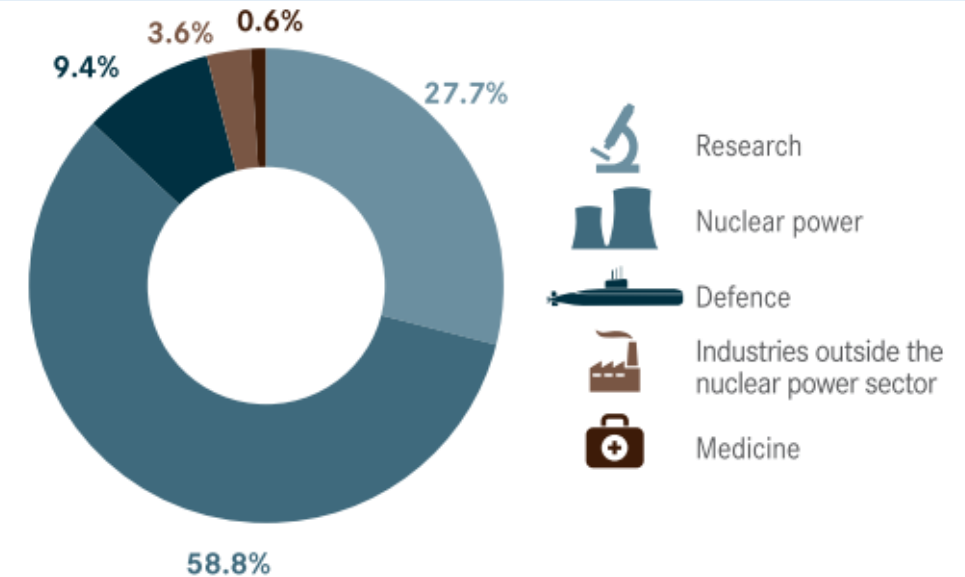

Where does nuclear waste come from in the nuclear cycle?



# Origin of Nuclear Waste

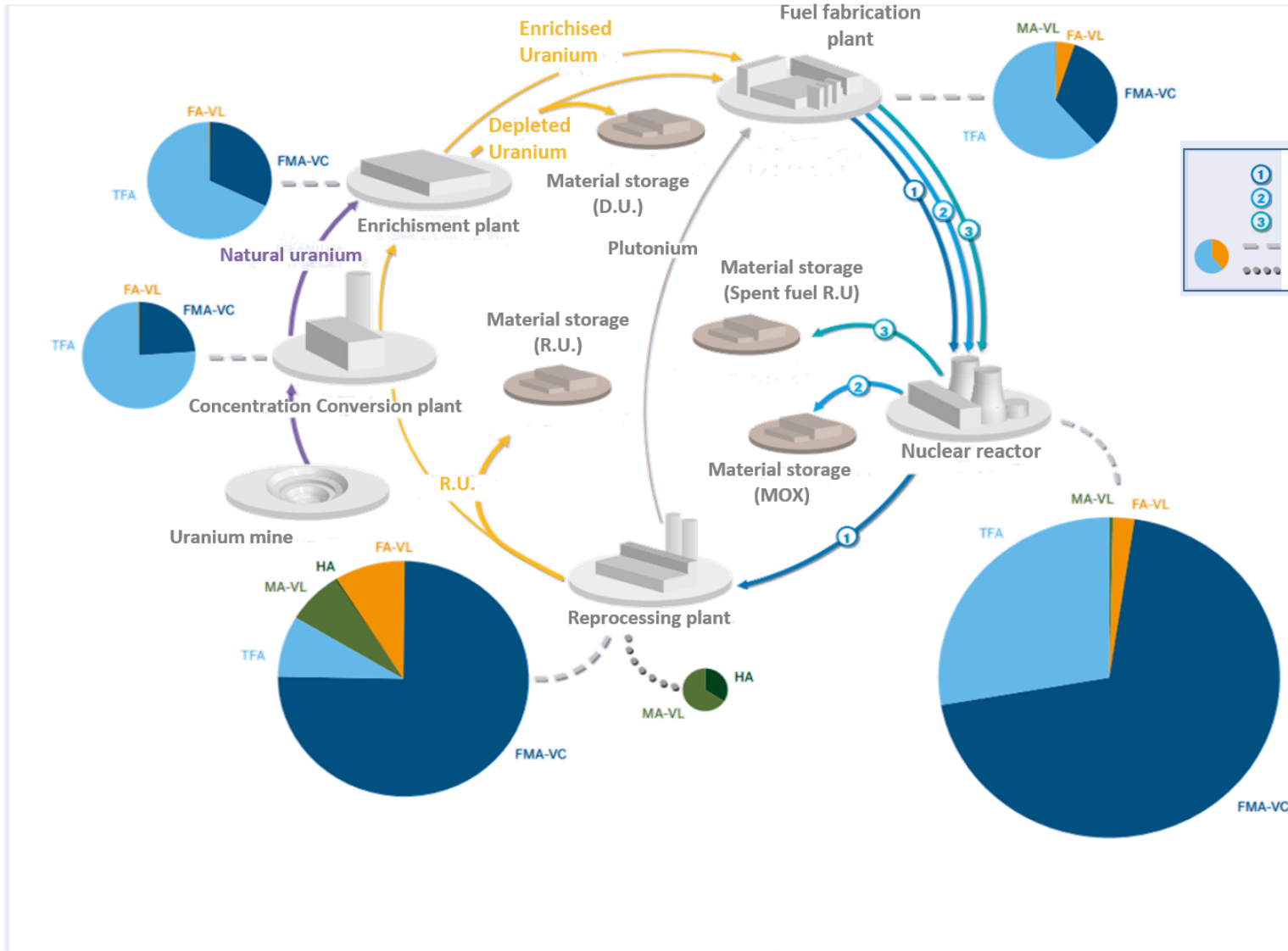

- Closed cycle
- 96 % of exploitable material
- 4 % of fuel waste

**Where do nuclear waste go after being generated?**

# The Conditioning Routes for Radioactive Waste

**Vitrification of fission elements**

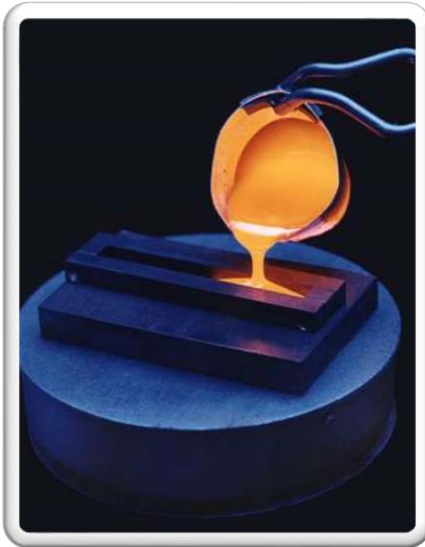

**Stabilization by solidification of nuclear waste**



**Packing**



**The common point of these conditioning routes is storage:  
what type of storage should be used?**

# Stabilization by Solidification of Nuclear Waste

The French National Radioactive Materials and Waste Management Plan (PNGMDR) describes the prescribed management solutions for the different categories of radioactive waste.

Management solutions: 4 types of disposal facilities ( 2 are currently operational & 2 are being studied)

## Operational management solutions :

- CSTFA disposal facility → The very-low-level waste disposal facility
- CSFMA disposal facility → The low- and intermediate-level waste disposal facility

## Studied management solutions:

- Near-surface repository project → Graphite waste (generated by the dismantling of Generation 1 GCRs) and radium-bearing waste.
- Deep repository project (CIGEO)

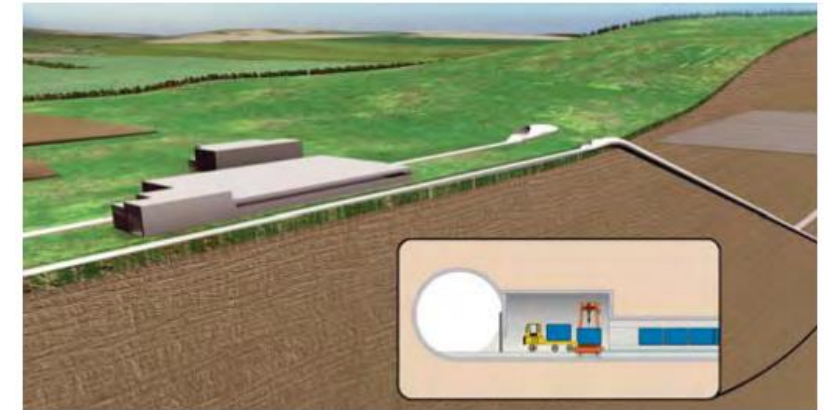

Near-surface repository with undisturbed cover

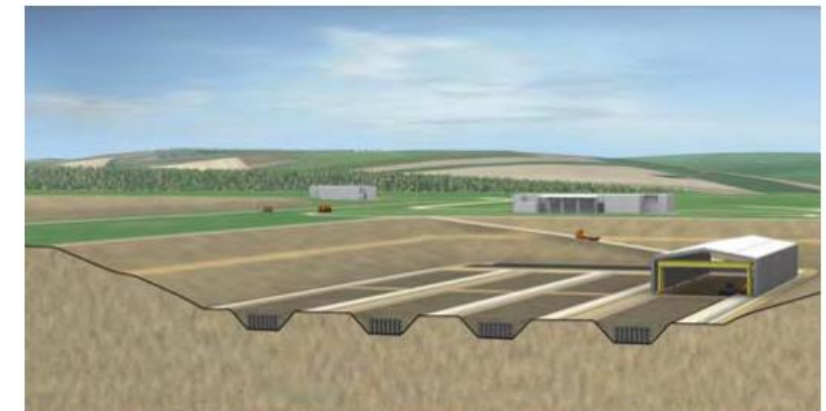

Near-surface repository with disturbed cover

# Surface Storage: VLLW Disposal



The very-low-level waste disposal facility → Dismantling of decommissioned French nuclear facilities.  
Waste packages are deposited in cells excavated in clay, which base is engineered to collect seepage water.

They are isolated from the environment by:

- a synthetic membrane surrounding the waste and linked to a monitoring system;
- a thick layer of clay underneath and on the sides of the disposal cells;
- a clay cover placed over the waste.

During the facility use, the cells are protected by tunnel-shaped removable covers and equipped with monitoring devices.

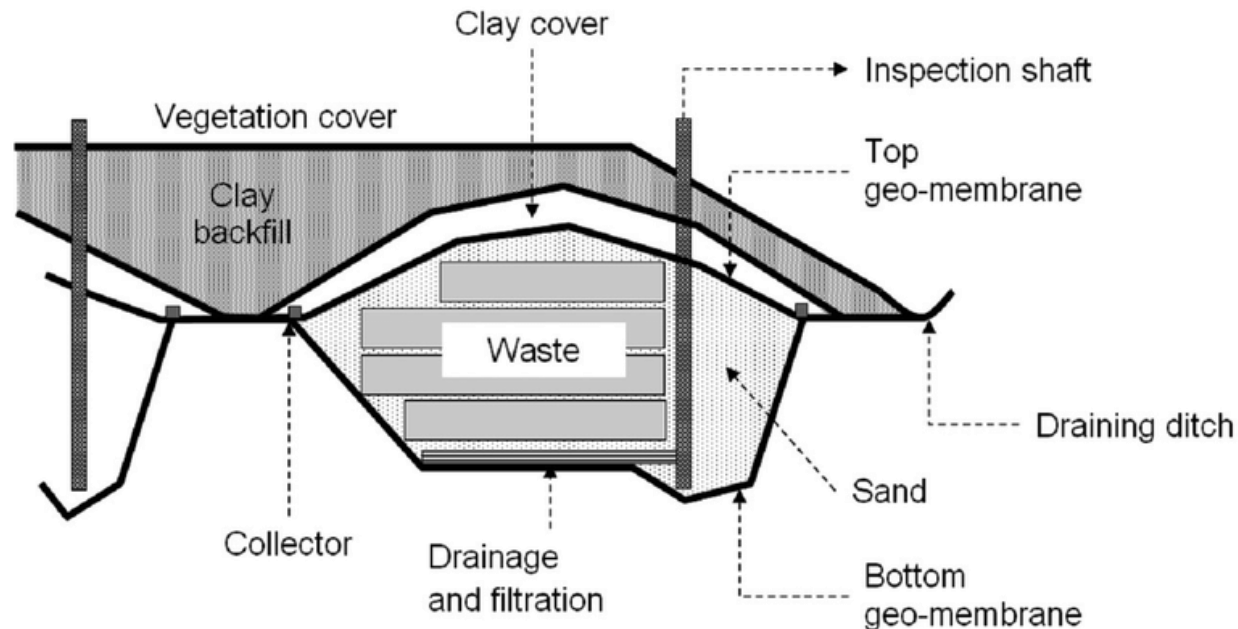



# Surface Storage: LILW Disposal



## The low- and intermediate-level waste disposal facility

It is made of reinforced concrete disposal cells 25 metres square and 8 metres high.

While a cell is being filled, packages are protected from rain by movable roofs.

Once a cell is filled, it is sealed by a concrete slab and covered with a leak-tight polyurethane layer.

It is also a seismic-resistant structure: disposal cells are built on an impermeable clay layer, which acts as a natural barrier in the event of accidental dispersal of radioactive elements to the ground- water.



# Deep Storage

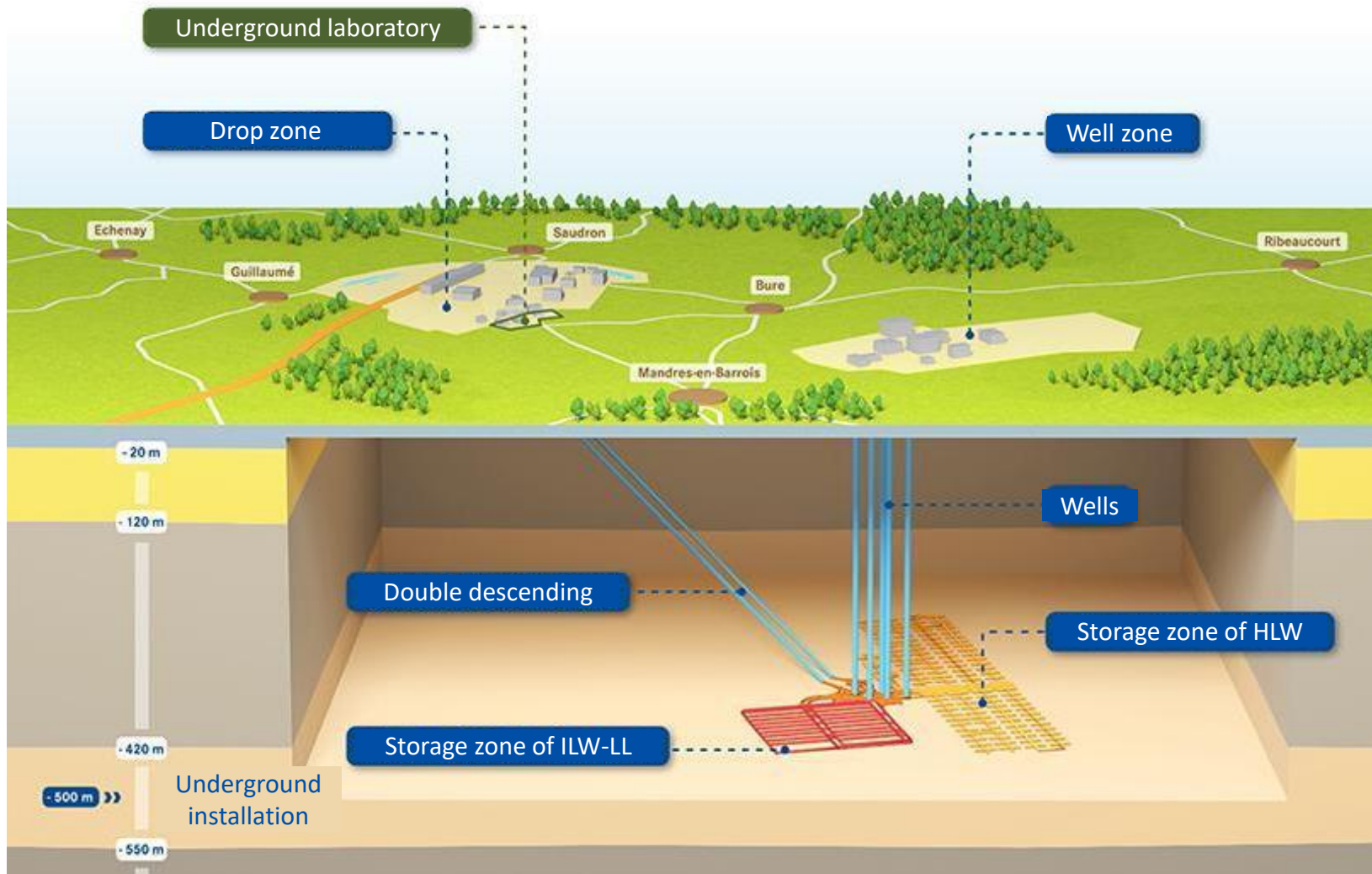

**Objective: protect humans and the environment from the danger of this waste in the very long term.**

- Underground disposal cells are excavated in an argillite claystone
- The site should allow the long-term containment of radionuclides contained in the waste.
- Should be in accordance with a *reversibility* principle
- Different storage zones depending on waste type

# Dismantling Challenge: Case of the UNGG Reactor



EDF Uranium Naturel Graphite Gaz (UNGG) reactor – Saint-Laurent-des-Eaux (© IRSN)

≈ 1 100 to 3400 T of waste per reactor

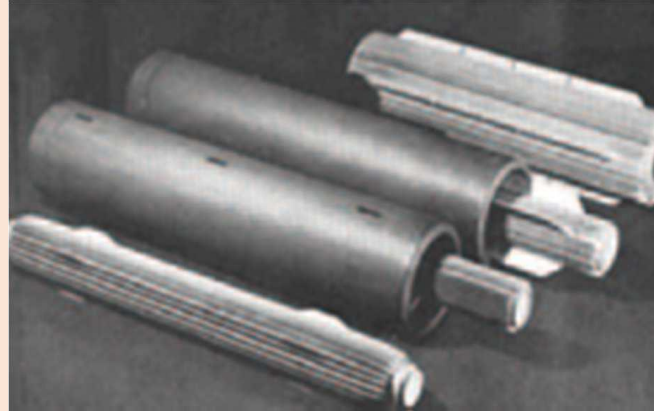

## Identity card

**Name:** Nuclear fuels

**State:** Spent fuels

**Origin:** Dismantling of UNGG reactors

- **Period of use:** from 1966 to 1990
- **Composition:** Graphite jackets – wire stainless steel saddle - Magnesium - Uranium in the heart of Mg
- **Stored in aluminium containers**
- **Processing/conditioning:** The project is to remove a large part of the chemical reactivity by a magnesium metal dissolution process and a uranium metal corrosion process. Secondly, all waste is cemented with a specific blocking slurry to manage chemical reactivity and limit H<sub>2</sub> production.

# Chemical Reactivity: Example of Aluminium Metal

Reactivity of aluminium depending on the porous solution  
(which depends on cement nature)

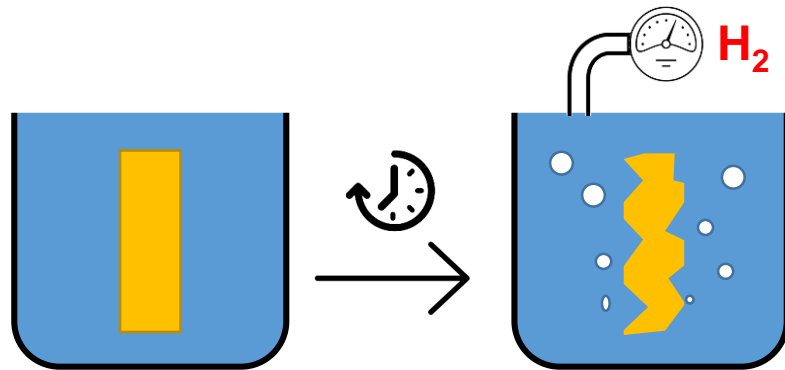

**✗ Corrosion & dihydrogen production  
→ potential explosive behavior**

If pH < 3



If pH > 9



Use of a  
specifically adapted  
cement, namely

**Magnesium potassium K Phosphate cement (MKP)**

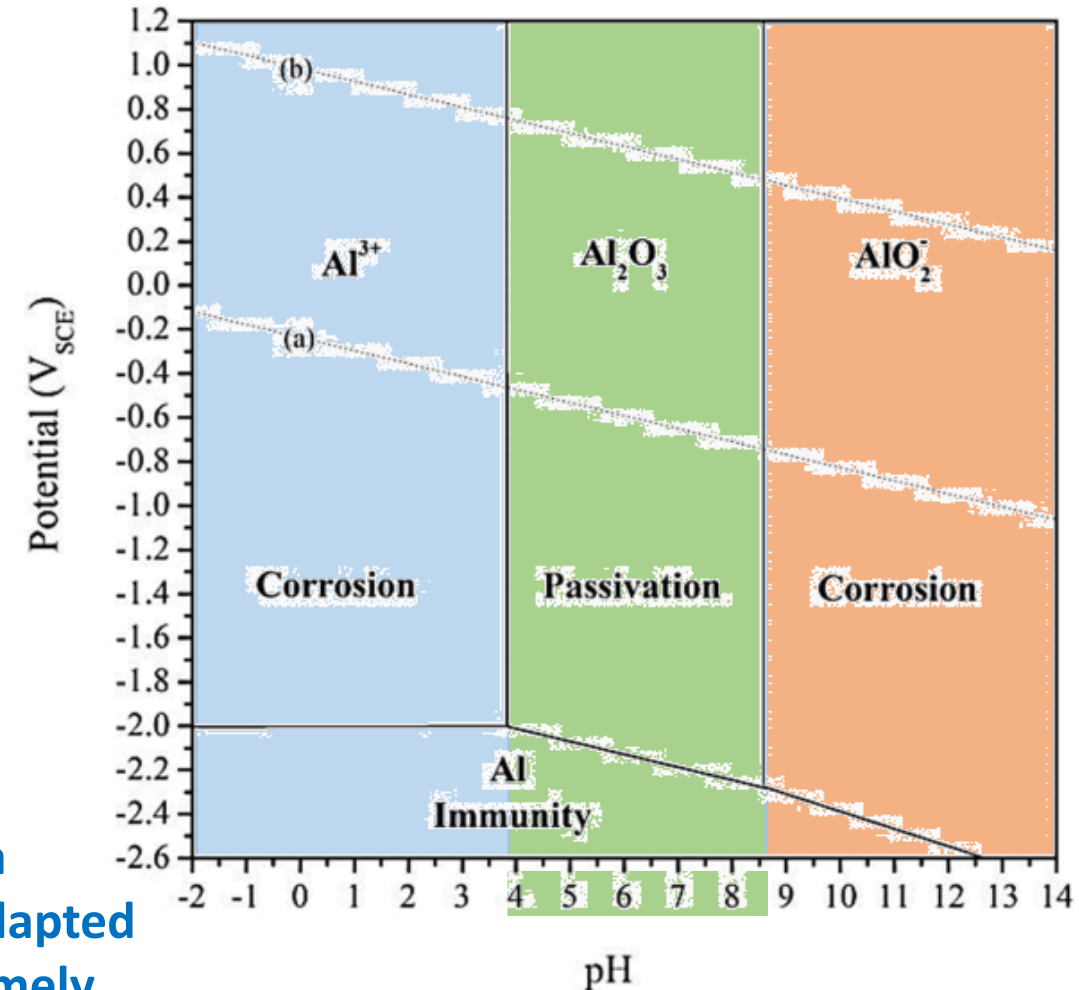

# Stabilization/solidification (S/S)

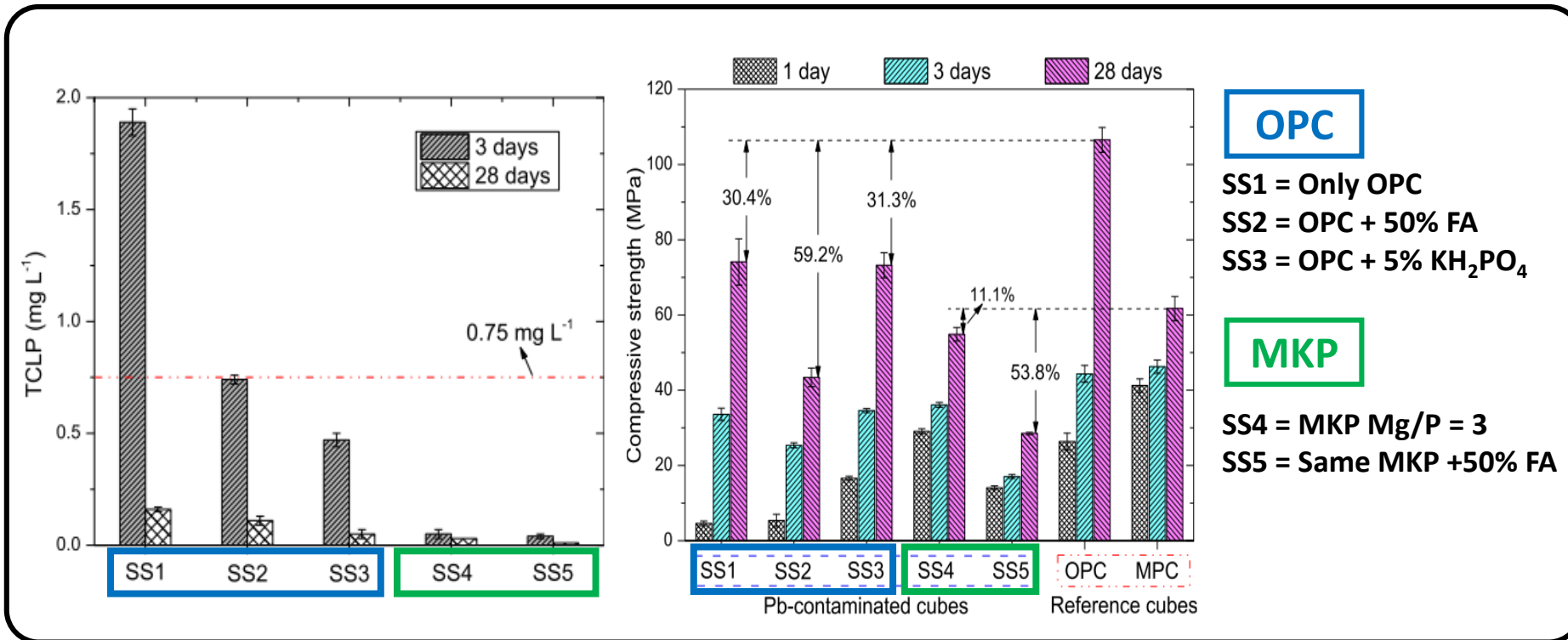

- 5 formulations with 0.01 Pb-to-cement mass ratio
- Quantity of lead leached is lower in the MKP matrix
- Higher mechanical properties are obtained for Portland cement
- Less mechanical loss in the case of MKP

OPC-based S/S of soluble Pb → Physical encapsulation by calcium-silicate-hydrate (C-S-H) gels (present in Portland cement)  
 MKPC-based S/S process → Chemical stabilization with residual phosphate and physical fixation by K-struvite cement.

**MKP is a more efficient and chemically stable inorganic binder for the Pb S/S process (compared to Portland cement)**



# Difference Between MKP & OPC

*Main difference between OPC and MKP cements*



**Hydration reaction**



**Acid / Base reaction**

**MKP history**

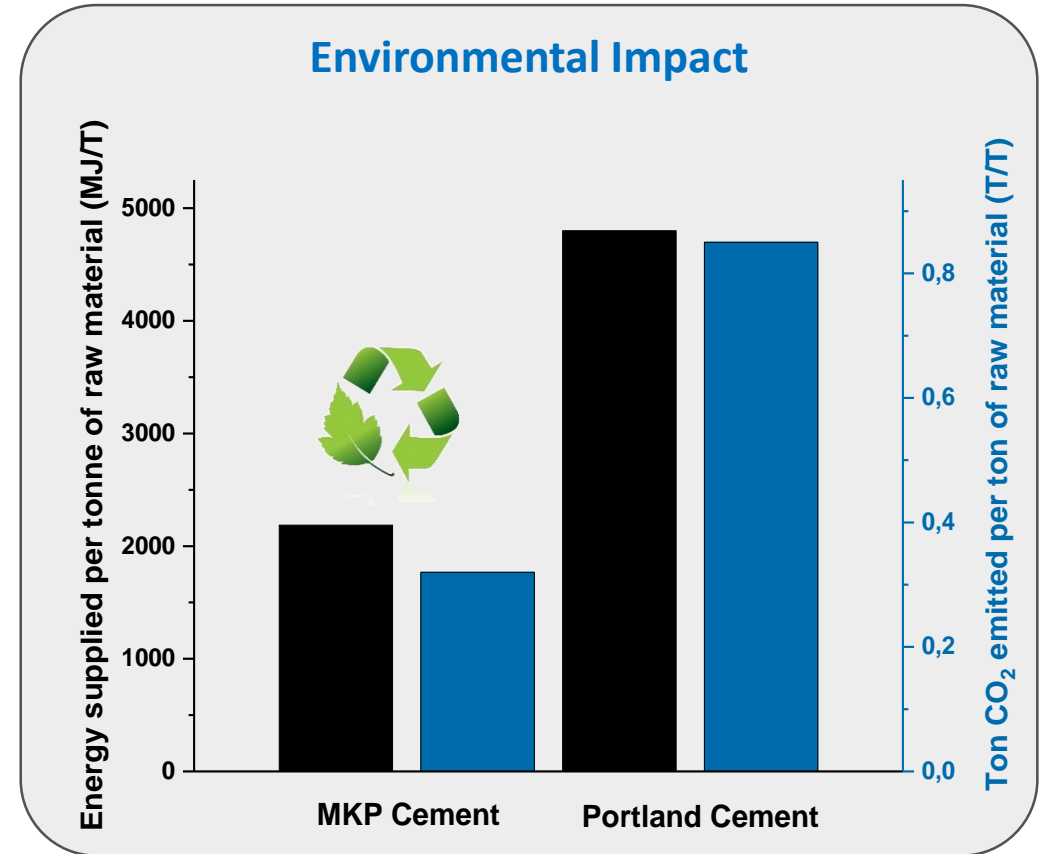
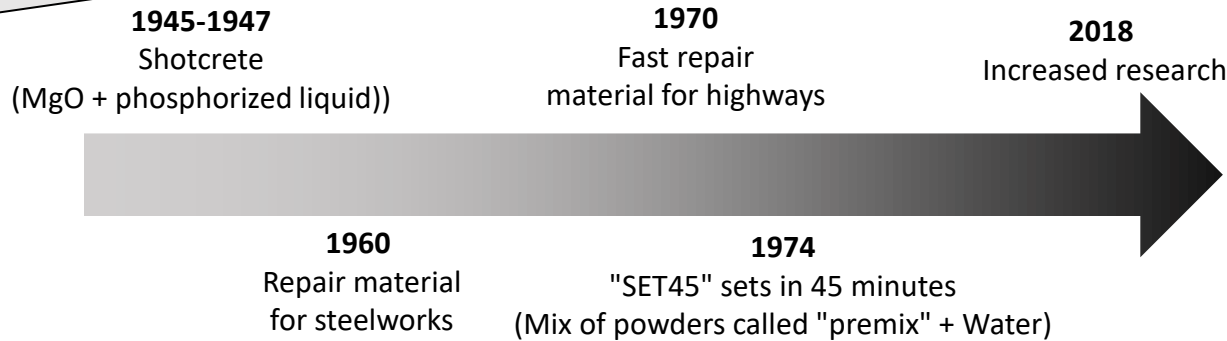



# Difference Between MKP & OPC

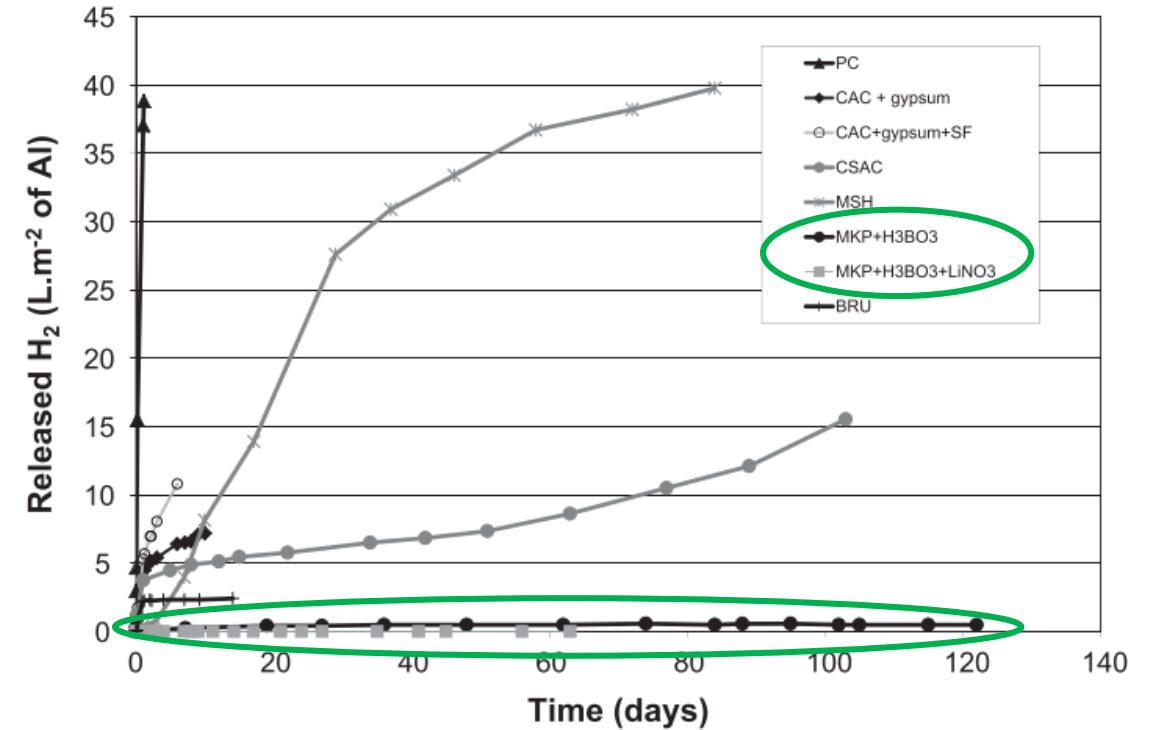
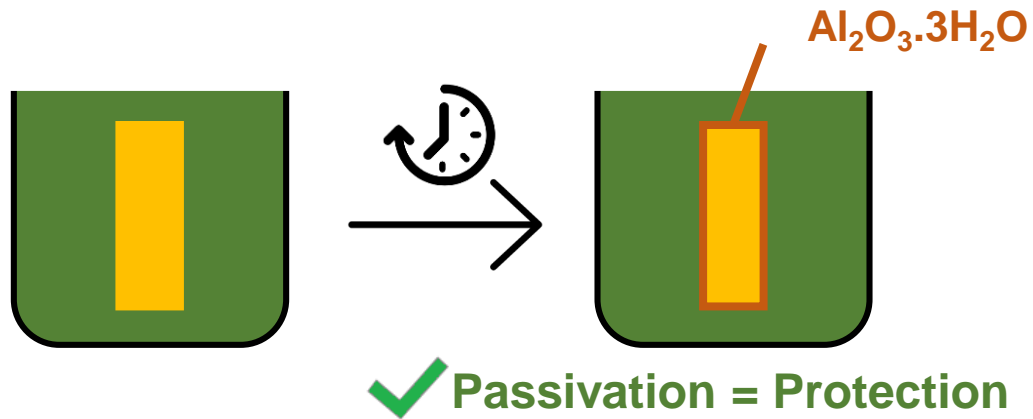
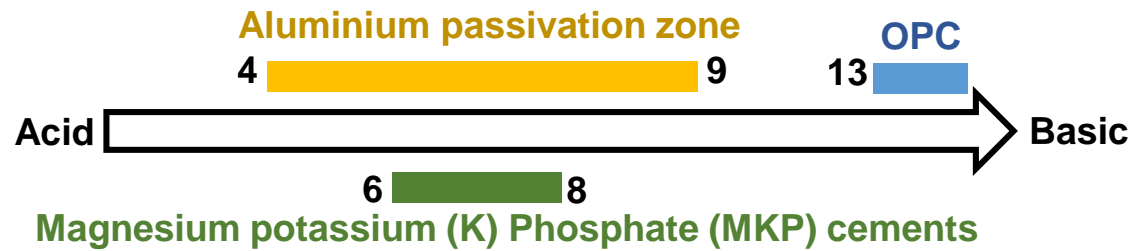

- PC: Portland cement
- CAC: Calcium aluminate cement
- CSAC: Calcium sulfoaluminate cement
- MSH: Magnesium siliceous binder
- BRU: Brushite cement
- MKP: Magnesium potassium phosphate cement

# Magnesium Potassium Phosphate (MKP) Cement

Formation of MKP cement:



- Theoretical molar ratio  $\text{MgO}/\text{KH}_2\text{PO}_4 = 1$
- For best mechanical performance  $\text{Mg}/\text{P} = 6$

Drawback : Hydration of magnesium oxide

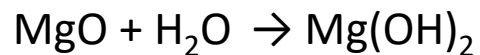

**Can damage the cementitious matrix due to volume change (swelling)**

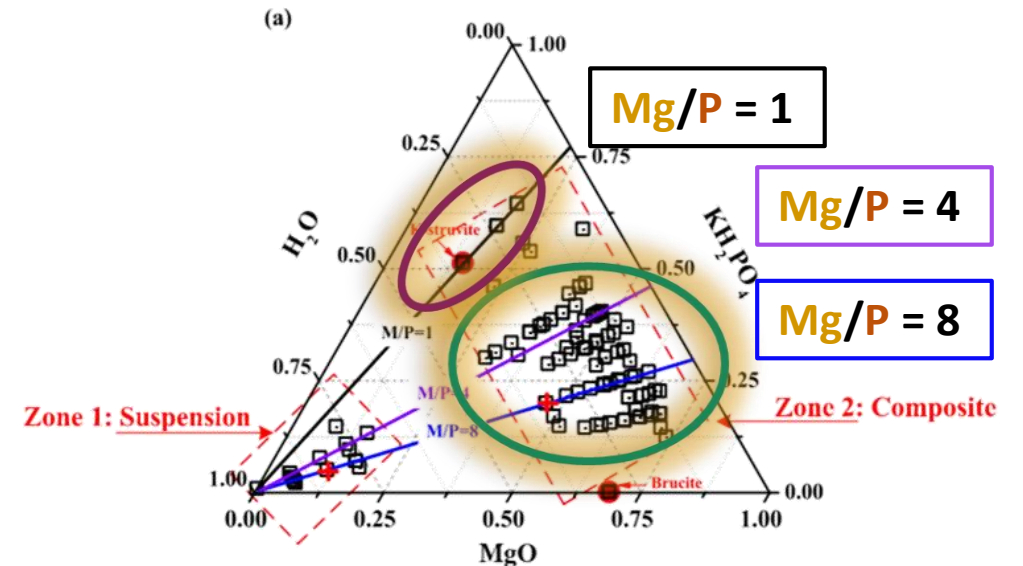

**Why use over-stoichiometric formulations?**

# MKP Cement: MgO Optimization

Why use over-stoichiometric formulations ?

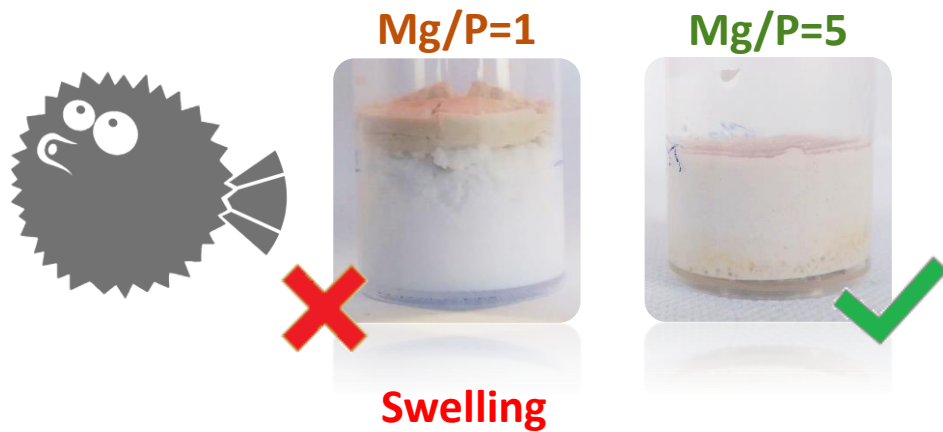

Effect of over-stoichiometric MgO ?

Physical

Chemical

Physico-chemical

If there is a physical effect of MgO on stoichiometry, what would be the effect of replacing it with mineral additives?

Investigation  
Use of fly ash (FA)  
Use of silica fume (SF)

# MKP Cement: Swelling Inhibition

## Volume variation

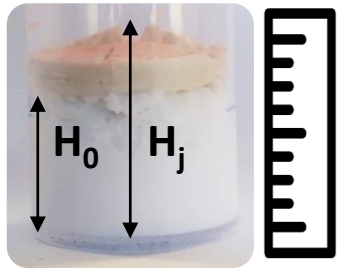

$$\Delta V = \frac{H_j - H_0}{H_0}$$

With  $H_j$  height at  $j$  days

$\Delta V > 1 = \textit{swelling}$

## Sample after 28 days



0.05    0.1    0.2    0.3    0.4    0.6    0.8    1

## Evolution of swelling according to F / C (Results for silica fume at 28 days)

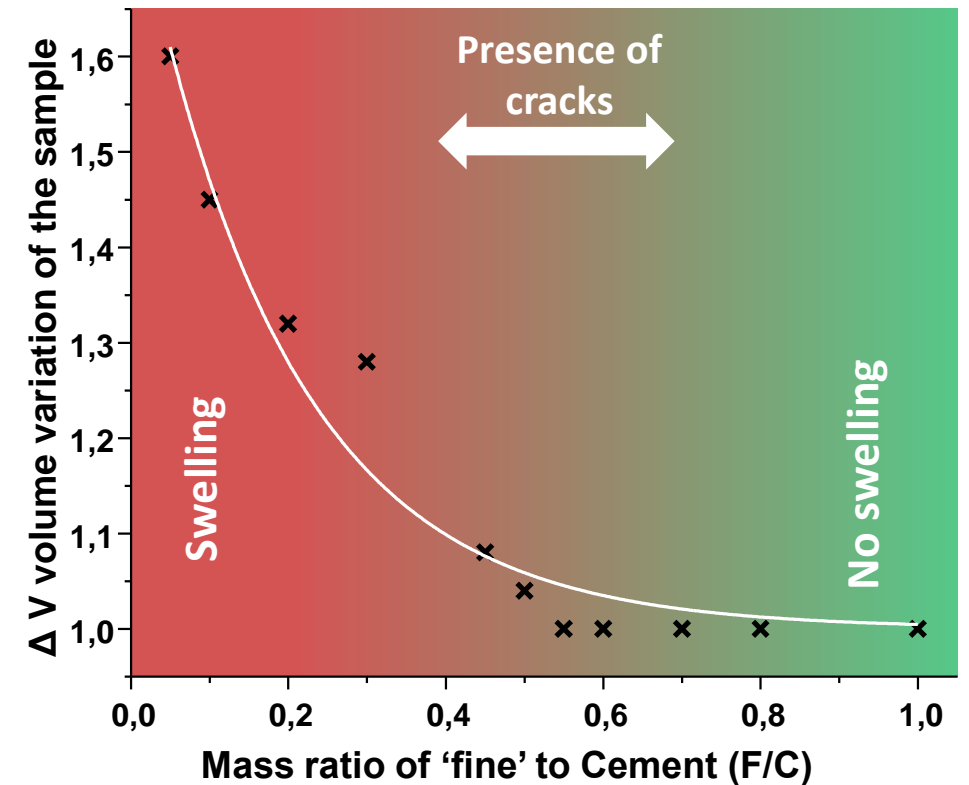

# MKP Cement: Stoichiometric Matrix

Stoichiometric matrix



Few minute after mixing raw materials

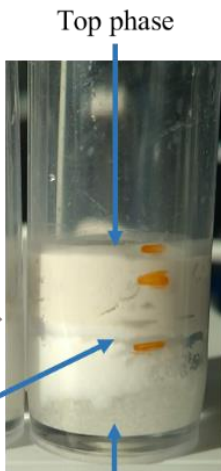

**Analysis of the swelling by TGA/TDA and by X-ray diffraction**

**Segregation of constituents with an increase in the amount of acid at the bottom of the sample**

**Hypothesis: Composition difference with pH gradient**

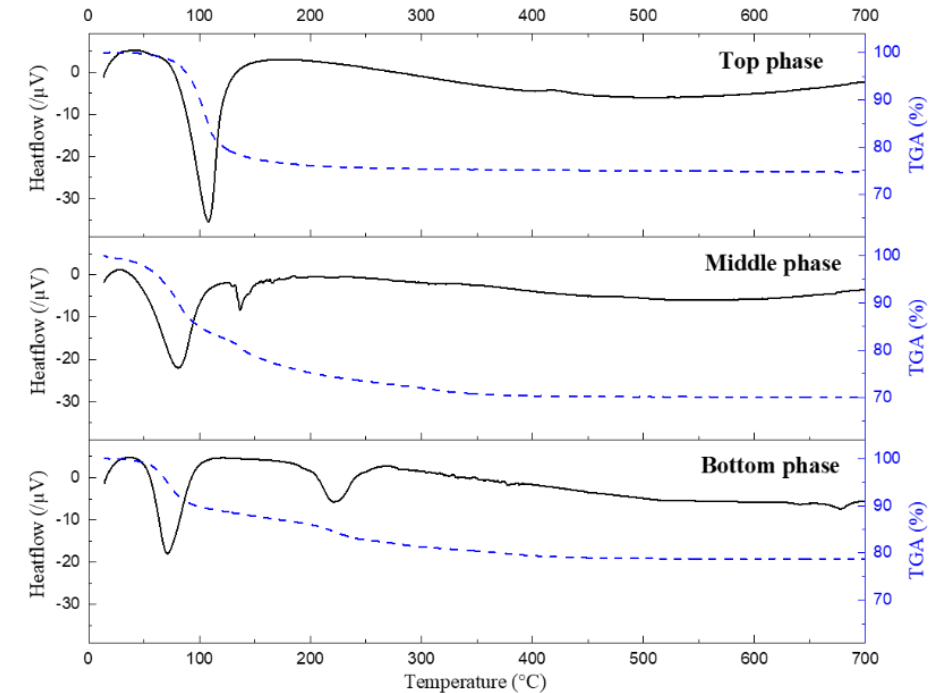

The addition of mineral powder avoids phase segregation and homogenizes the different components.  
Now, what is the quantity of binder phase?



# Magnesium Potassium Phosphate Cement

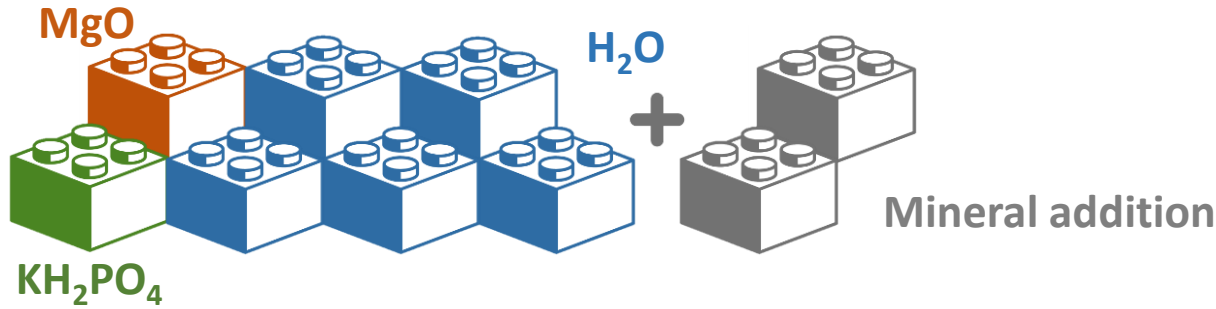

Mass ratio Fine/Cement (F/C) = 1

- Conversion into volumetric proportion (due to the difference in mineral density)
- 3 formulations using MgO, FA & SF

## Thermal decomposition :

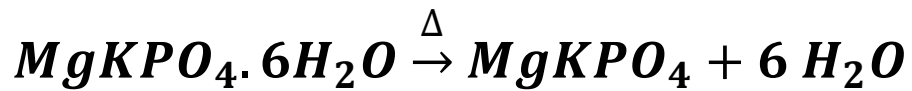

Water quantity is determined to access the K-Struvite quantity

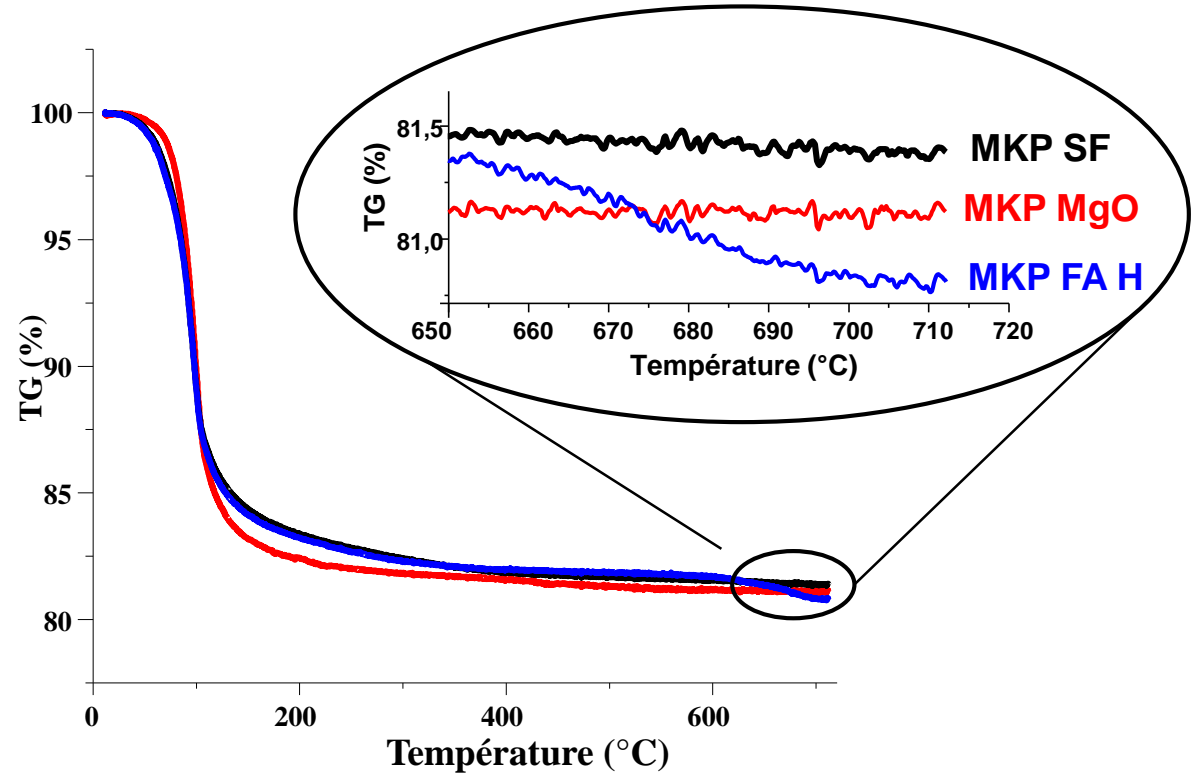

Silica fume	FA Harnes	MgO
-------------	-----------	-----

Mg/P = 1

Mg/P = 1

Mg/P = 5,38

R<sub>K-Struvite</sub> : 43,4 %

40,7 %

46,4 %

# MKP Cement: Mechanical Characterization

- **Depending on its mechanical properties, the application of the final matrix will be different:**
  - High strength (> 60 MPa) → structure material
  - Normal to low strength (<60 MPa) → Blocking material for stabilization/solidification
- **Possibility to work with a Mg/P = 1**
- **Possible substitution of over-stoichiometric MgO with waste powder, in order to make cheaper matrices (and reduce cost in MgO)**
- **Fly ash addition decreases the mechanical performance of MKP cement matrix**
- **In progress work: study of dimensional stability**

# Portland Cement

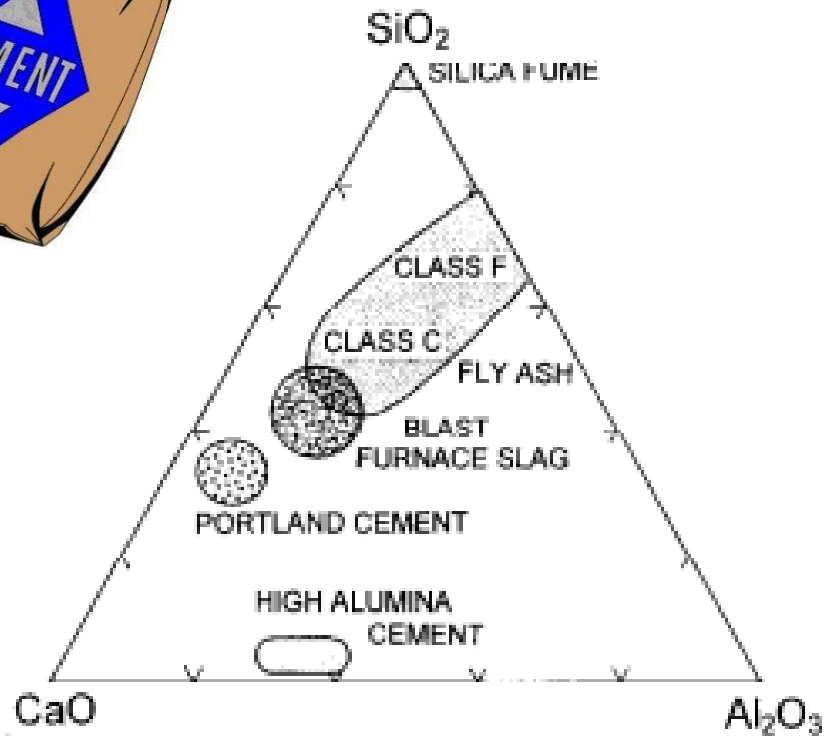

Ordinary Portland Cement (OPC) is a hydraulic binder produced by firing a mixture of limestone and clay at over 1400°C. The product obtained after "baking" and quenching is called clinker.

Composition:



Type of reactions: Hydration by multiple reactions (solid solution CSH)

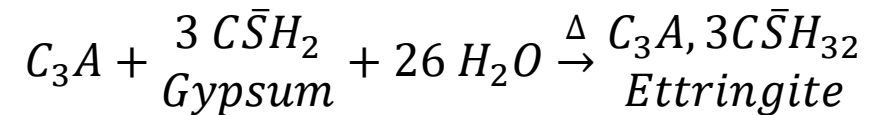
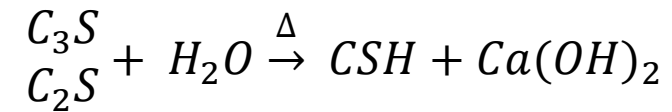

Characteristic: Alkaline pore solution

**Used in stabilization/solidification of heavy metals**

# Portland Cement

How to add mineral powders to OPC mortar?

Physical integration → Fill in the gaps

Use of an accelerated protocol for strength development

Best compressive strength → 10% Fly ash / Cement mass

The formulation has a significant impact on compressive strength

Mortar with FA addition

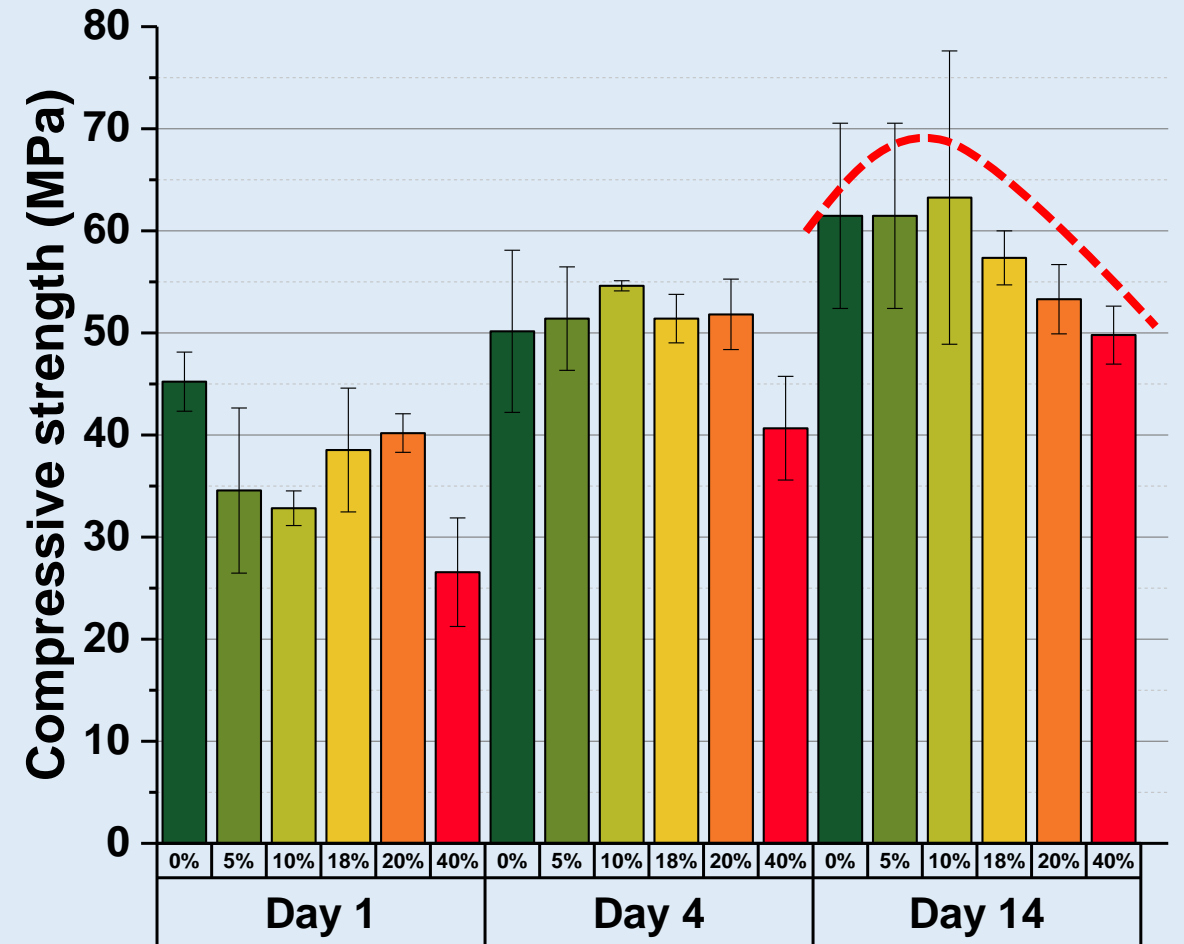

# Physical Integration?

- Compressive strength depends on the granular skeleton
- 3 possible cases

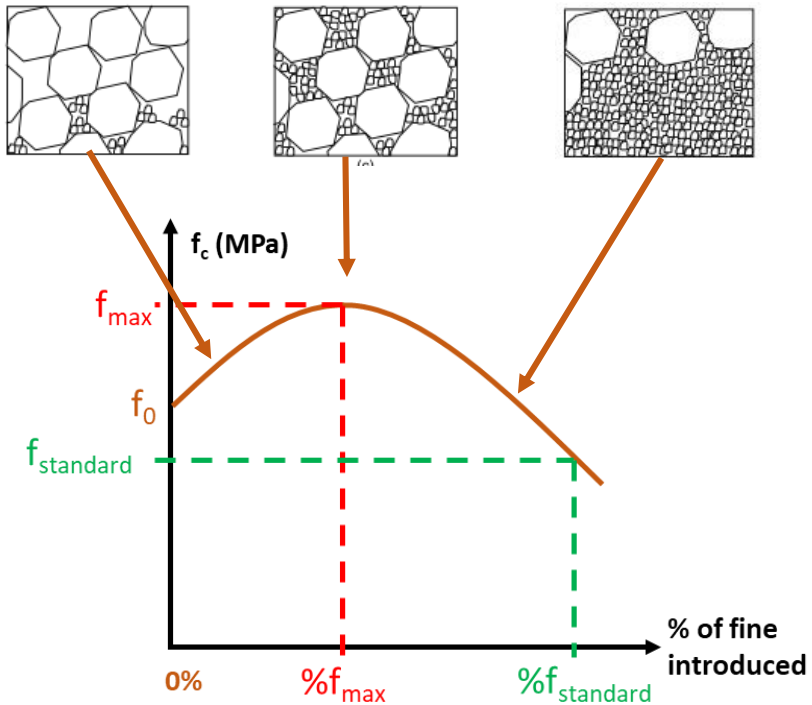

Filler addition can increase compressive strength and decrease fluid transport (permeability) and hence, durability

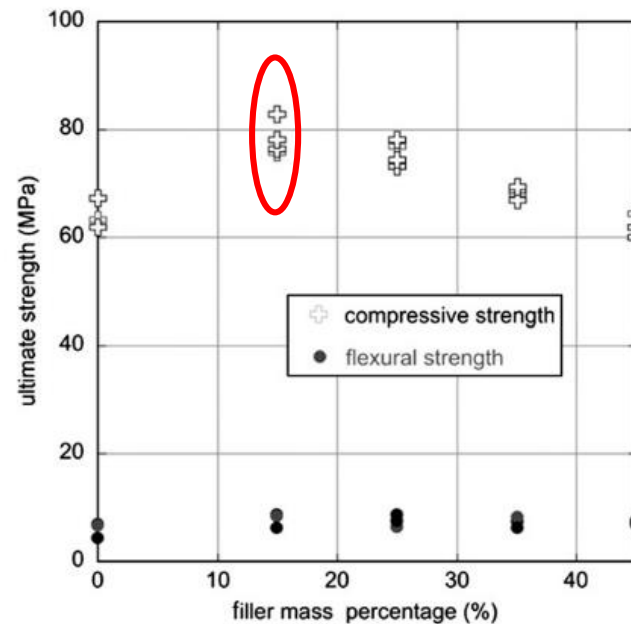

Fig. 11. Variation of ultimate compressive stress  $\sigma_{ucs}$  and ultimate flexural stress  $\sigma_{ofs}$  as a function of filler mass percentage.

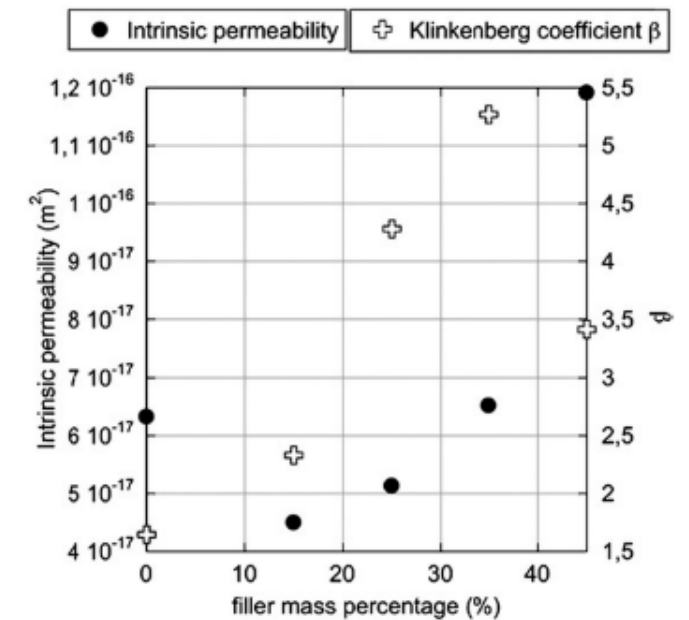

Fig. 13. Variation of intrinsic permeability and Klinkenberg coefficient  $\beta$  as a function of filler mass percentage.



# Physical Integration of Nuclear Waste

- **Applications ?**

- Formulation for specific waste encapsulation
  - Stabilization/Solidification of nuclear waste

- **Industrial specifications**

- Mechanical resistance
  - Good rheology
  - Thermal resistance
  - Maximum incorporation of this material

- **Demonstrate feasibility to enable to scale-up while unlocking the technological locks**

**Waste integration**

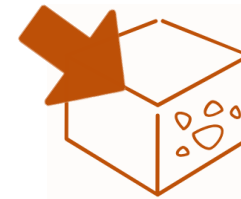

**Good workability**



**Mechanical performance**



**Good leaching behavior**

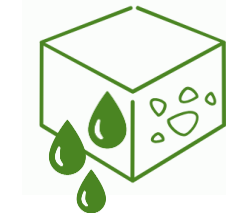

# Test Miniaturization

## Physical characterization: workability

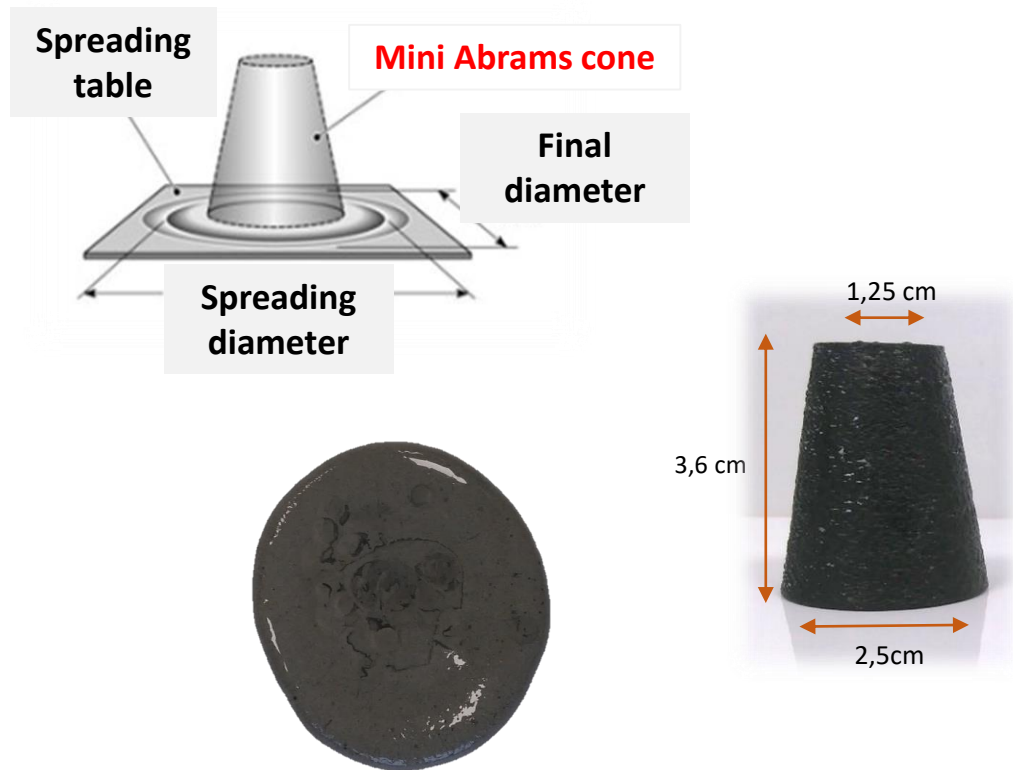

Access to rheological behavior

## Physical characterization: mechanical test



Access to compressive strength

# Compressive Test Miniaturization

Methodology used for mechanical tests:

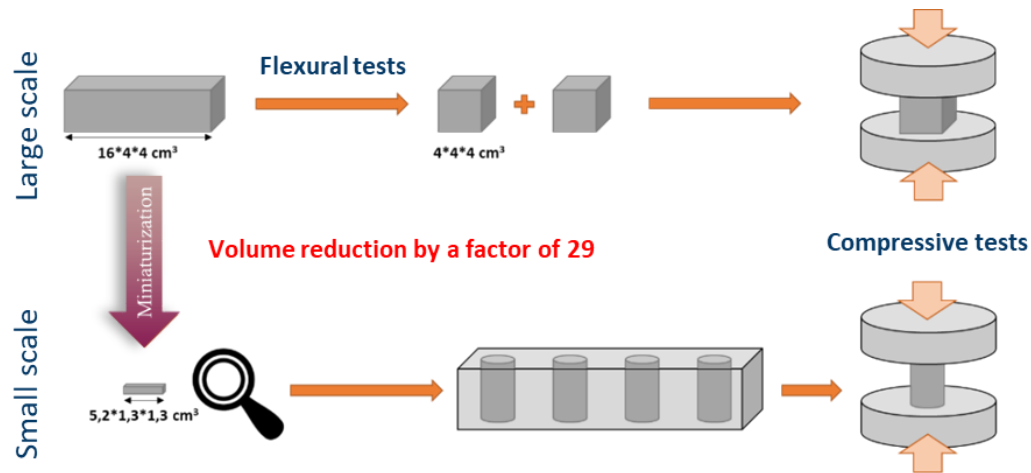

Compression tests on specimens of 4\*4\*4 cm<sup>3</sup>

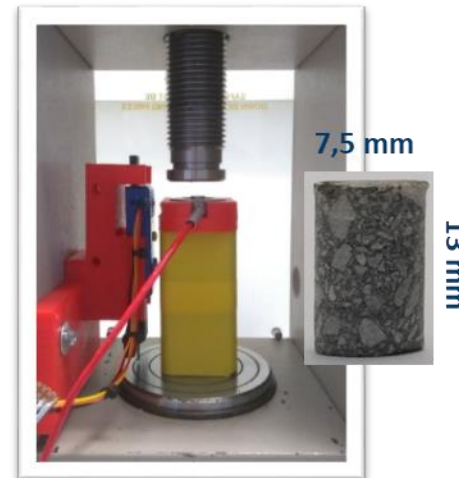

Compression tests on specimens of Ø7,5 mm \* H13 mm

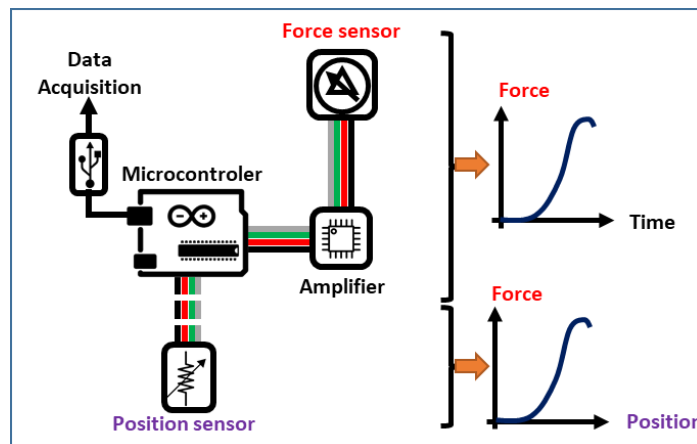

Compressive results at 1 and 4 days for the same formulation

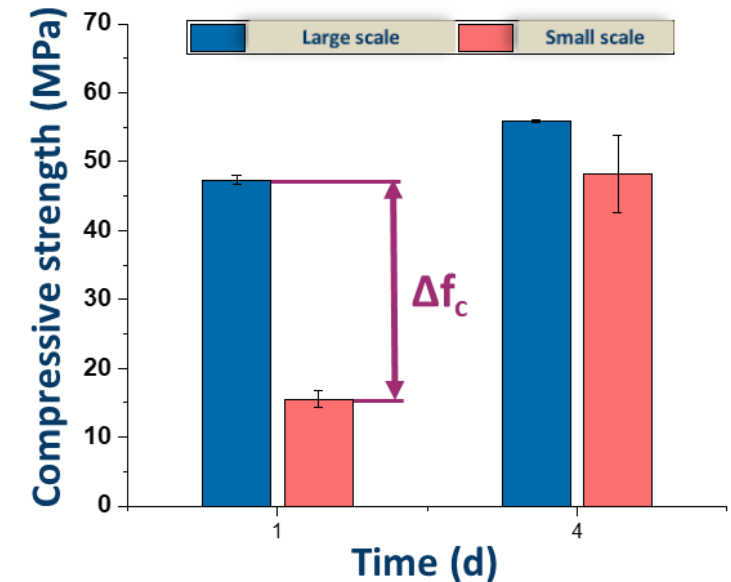

Difference due to volume change

# Compressive Test Miniaturization

Volume change = Compressive strength difference at 1 day!

Hypothesis:

Decrease in reaction kinetics related to volume change (Small/Large scale) by a factor of 29

Heat of hydration is dependent on sample volume (Lee et al. 2014)

This influences the reaction kinetics

Arrhenius law type:

$$k' = A * e^{\left(-\frac{E_a}{RT}\right)}$$

- Influences kinetics → influences the hydration products
- Influences compressive strength

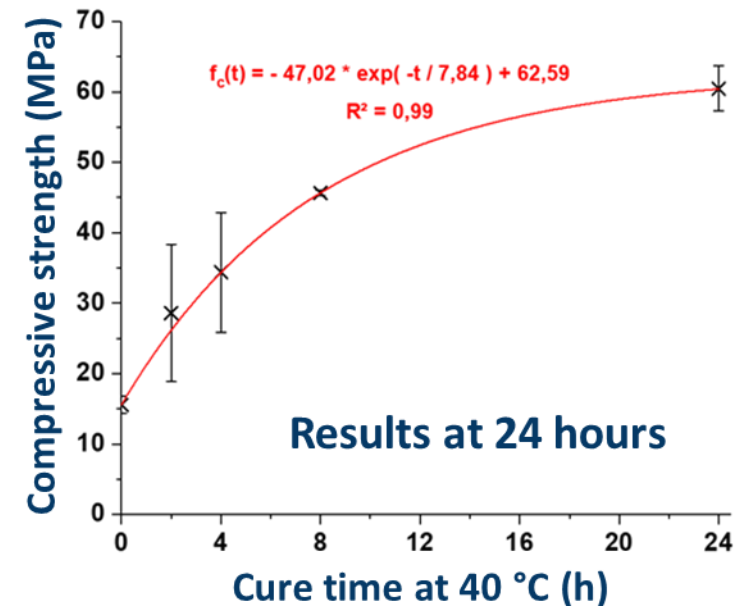
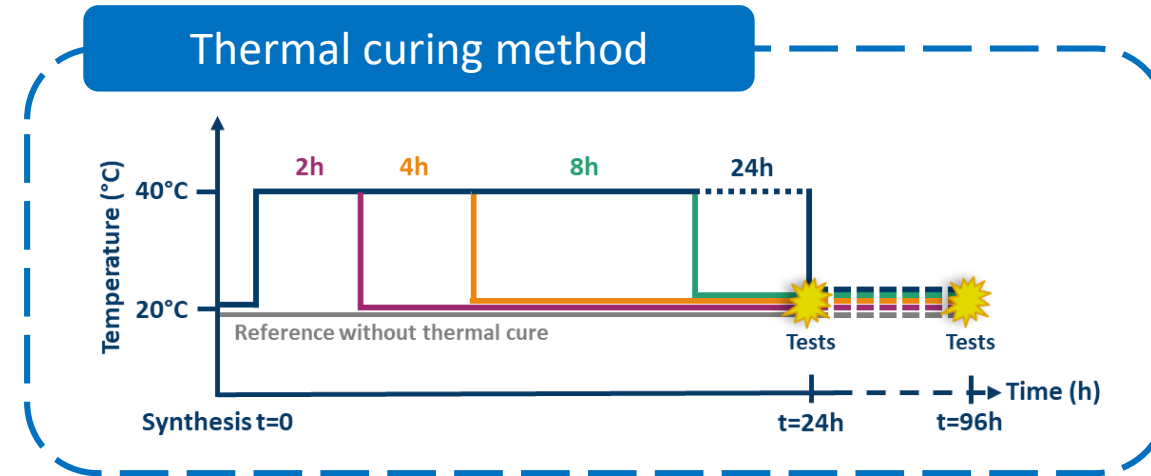



# Conclusion

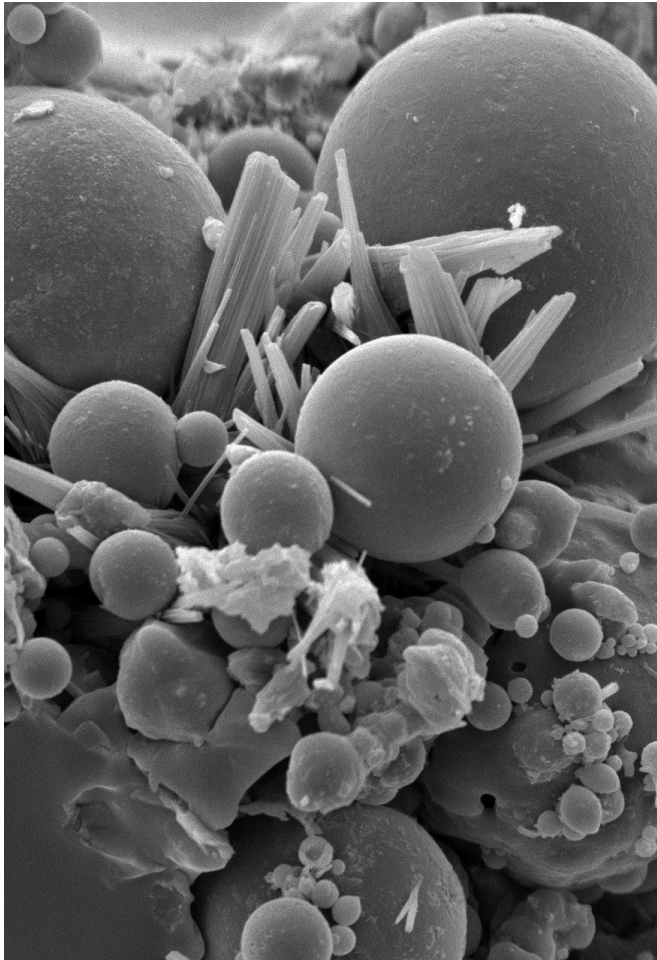

**Dismantling generates many different type of wastes.  
The chemical nature of this waste is the main difficulty in managing it during dismantling.**

**This is why the development of new adapted cementitious matrices is important to ensure safe handling & protect humans from their toxicity.**

**The formulation of innovative matrices requires:**

- **Implementation of specifications according to the intended use**
- **Use of a cementitious matrix appropriate to the waste**
- **Formulation tests**
- **Performance optimization (physical, leaching...)**
- **Understand the physico-chemical phenomena involved**

**The use of these new materials will make it possible to answer different challenges, which involve safety, technological, environmental and financial issues**



# Upcoming Webinars

- |                |  |  |
|----------------|--|--|
| 19 June 2019   | Interactions Between Sodium and Fission Products in Case of a Severe Accident in a Sodium-cooled Fast Reactor                        | Mr. Guilhem Kauric, CEA, France  |
| 31 July 2019   | Security Study of Sodium-Gas Heat Exchangers in Frame of Sodium-cooled Fast Reactors   | Dr. Fang Chen, CEA, France   |
| 29 August 2019 | Lead Containing Mainly Isotope $^{208}\text{Pb}$ : New Coolant, Moderator and Neutron Reflector for Innovative Fast Nuclear Reactors | Dr. Evgeny Kulikov, National Research Nuclear University "MEPhI," Russia |