



# GAS COOLED FAST REACTORS

Alfredo Vasile

CEA

22 February 2017



Canadian Nuclear  
Laboratories  
Laboratoires Nucléaires  
Canadiens



# Meet the presenter



**Alfredo VASILE** obtained his Master in Physics at the Balseiro Institut (CNEA, Argentine), and his Doctor on Nuclear Engineering degree at the Grenoble University (France) in 1977. He joined CEA in 1981 working at RAPSODIE sodium cooled experimental fast reactor at Cadarache. He held laboratory head positions on core physics and safety studies both for light water reactors and fast reactors.

Dr. Vasile participated at the Gen IV Roadmap definition process as a member of the Light Water Reactors Technical Group and was the French representative of the INPRO Steering Technical Committee for the Joint Study on Closed Nuclear Fuel Cycle with Fast Reactors.

He is presently project manager of the ESNII Plus European Project on fast reactors, the French representative at the IAEA Technical Working Group on Fast Reactors, GIF GFR Steering Committee, GIF GFR Conceptual Design and Safety and GIF SFR Safety and Operation Project Management Boards.

He is the CEA representative for the ALLEGRO GFR experimental reactor project.



Email: [alfredo.vasile@cea.fr](mailto:alfredo.vasile@cea.fr)

# Outline



- Why gas cooled fast reactors ?
- GFR concept: a historical perspective
- Today: Generation IV GFR
- Performance requirements for the Gen IV GFR system
- R&D requirements for the Gen IV GFR system
- Specific challenges:
  - Core and fuel
  - Decay heat removal
  - Materials
- Conclusions

## Why have gas cooled fast reactors ? (1/2)

- Fast reactors with closed fuel cycle are needed for the sustainability of nuclear power:
  - More efficient use of fuel
  - Reduced volumes and radiotoxicity of high level waste
- Gas cooled fast reactors have some favorable features
  - Gas (Helium) is chemically inert,
  - Very stable nucleus,
  - Void coefficient is small (but still positive),
  - Single phase coolant eliminates boiling
  - Optically transparent.
  - Allows high temperatures for increased thermal efficiency and industrial applications

## Why have gas cooled fast reactors ? (2/2)

- But ...
  - Gaseous coolants have small thermal inertia ➡ fast heat-up of the core following loss of forced cooling;
  - Need of pressurization
  - Low thermal inertia of the core structures and high power density
- Motivation is two-fold: enhanced safety and improved performance

# Gas cooled fast reactor concepts

## Historical perspective



- US, General Atomics – The GCFR programme
  - Started in the 1960's
  - Capitalised upon High Temperature (thermal) Reactor (HTR) experience:
    - Peach Bottom and Fort St Vrain
  - Funded by US DOE
  - Collaboration with European partners
- Helium cooled reactor with a multi-cavity pre-stressed concrete pressure vessel. Featured a vented fuel pin fuel element design to reduce fuel clad stresses.

# General Atomics GCFR concept

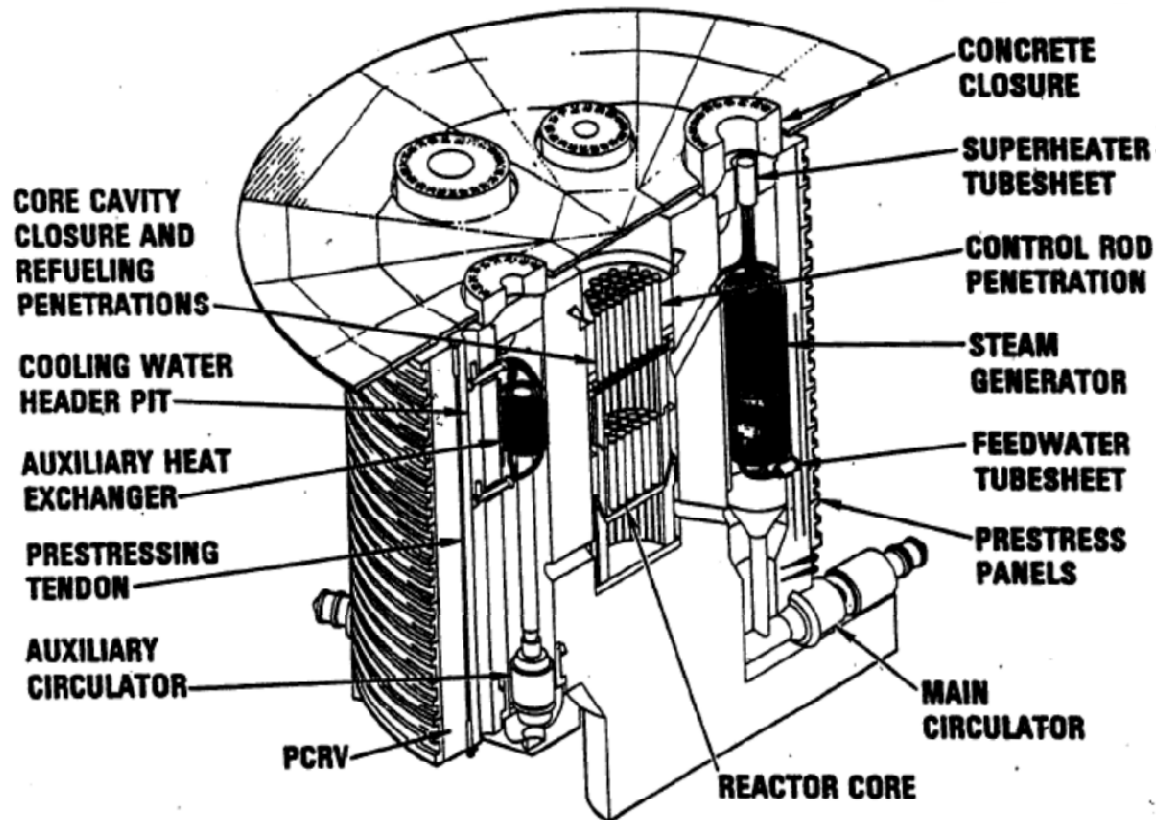

# Germany: the Gas Breeder Memorandum (1969)



- The German research centres at Karlsruhe and Jülich, together with industrial partners, defined three concepts, all cooled by helium,
- Fuel assemblies extrapolated from sodium cooled fast reactors,
- Pre-stressed concrete pressure vessels
- Steam cycle,
- Some work was carried out on coated particle fuels and direct cycle power cycles.



## Europe: the Gas Breeder Reactor Association (1970 - 1981)

- A number of organizations joined to form the Gas Breeder Reactor Association.
- The first design produced by the group was GBR-1, a 1000MWe helium cooled reactor with metallic clad pin type fuel and a secondary steam cycle.
- GBR-2, 1000MWe reactor using coated particle fuel, slightly elevated outlet temperature, helium coolant,
- GBR-3 1000MWe reactor using coated particle fuel, CO<sub>2</sub> coolant
- GBR-4 design was developed to overcome the complexities of the particle bed fuel elements.
  - metallic clad fuel pins held in spacer grids.
  - the clad surface was ribbed to maximise the core outlet temperature whilst respecting clad temperature limit.

# GBR-2, GBR-3 and GBR-4 designs

GBR-2

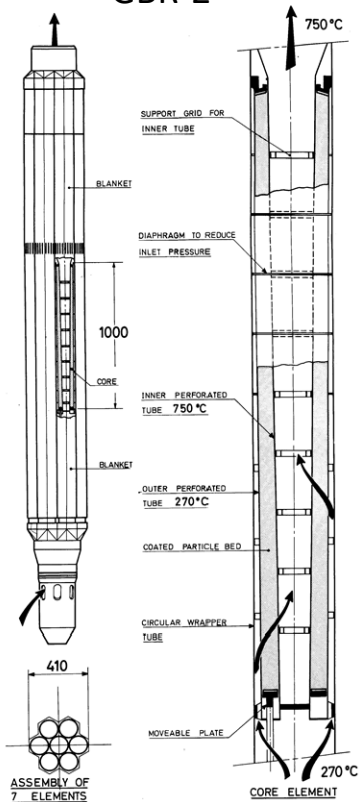

GBR-3

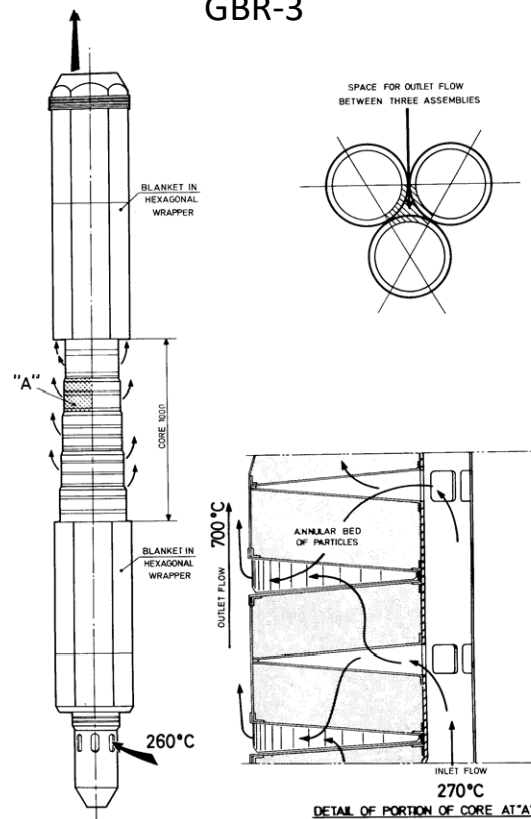

GBR-4

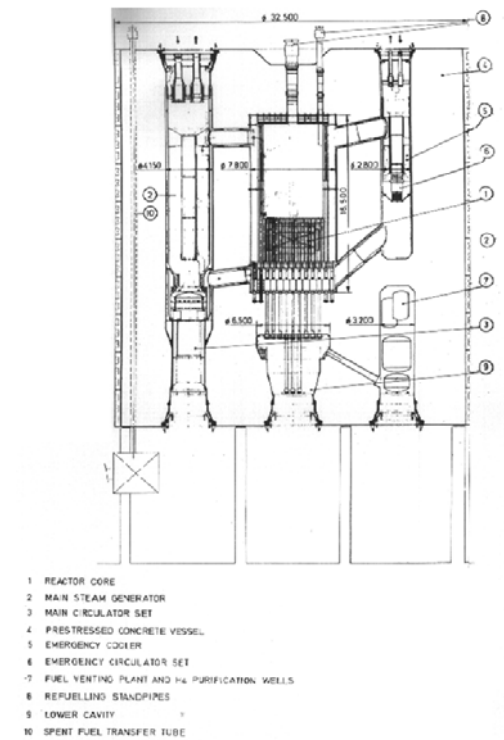

## UK: ETGBR/EGCR (1970s-1990s)

- Based on UK Advanced Gas cooled (thermal) Reactor architecture
- Metallic clad fuel
- Carbon dioxide coolant
- Pre-stressed concrete pressure vessel

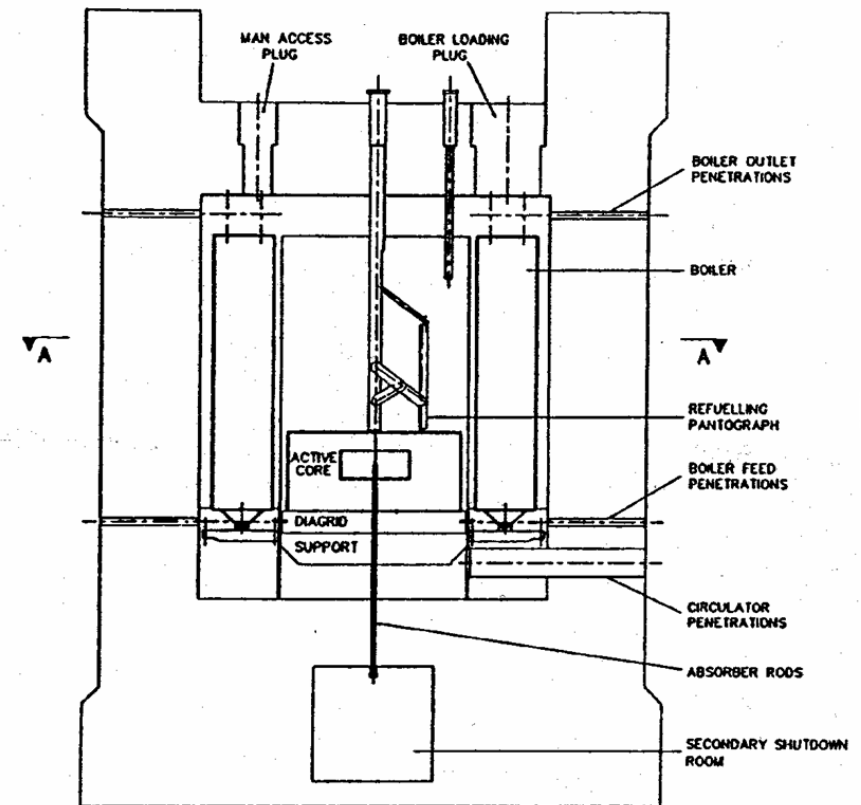

# Japan: Prismatic Block Fuel (1960s – 2010s)

- Japan investigated block fuel containing coated particles and packed bed (GBR-2 type) fuel elements.

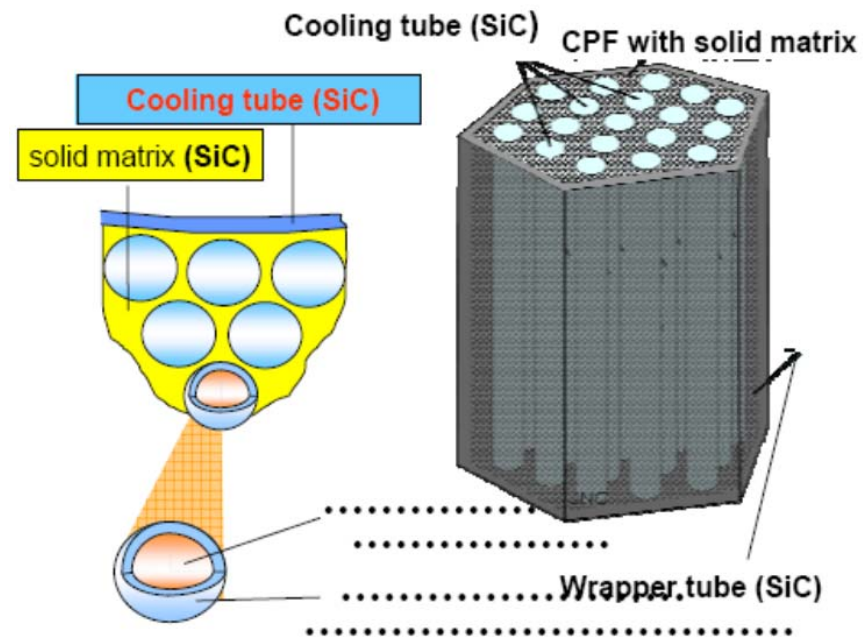

# Generation IV

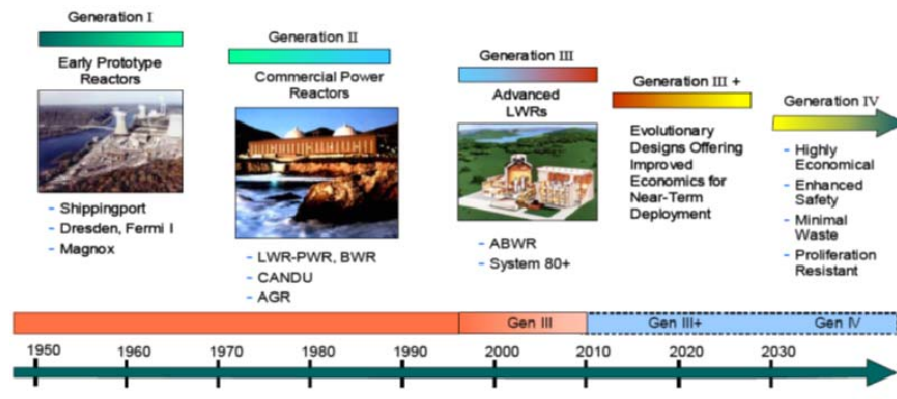

Generation IV: A renewal of interest in fast reactors for sustainability, waste minimisation and non-electricity applications.



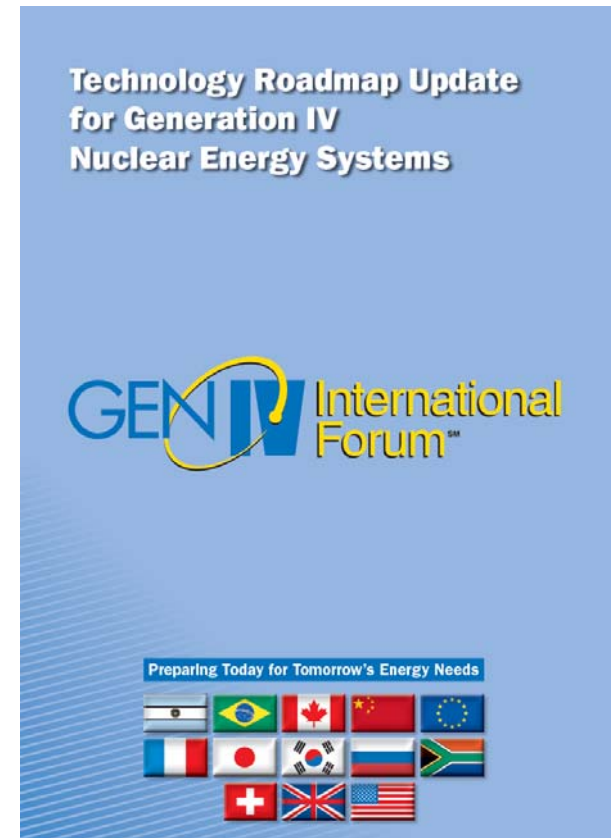







Six systems are proposed, three of which are fast reactors, sodium, lead and gas cooled fast reactors (and now the molten salt reactor is being developed to be a fast reactor)



# Generation IV



(year of Charter signed)

	 Canada (2001)	 China (2006)	 France (2001)	 Japan (2001)	 Korea (2001)	 <i>Russia</i> (2006)	 RSA (2001)	 Swiss (2002)	 USA (2001)	 EU (2003)
SFR		●	●	●	●	●			●	●
VHTR		●	●	●	●			●	●	●
LFR*				●	●	●				●
SCWR	●	●		●		●				●
GFR			●	●						●
MSR*			●			●		●		●

\*All activities, except LFR and MSR (based on MoU), are carried out based on the **system arrangement**.



Australia  
(2016)

Australia signed the Charter on 22 June 2016.



Argentina  
(2001)

Brazil  
(2001)

UK  
(2001)

are also members as non-active member.

# The Gen IV GFR system

~ 850 °C



(Observer)

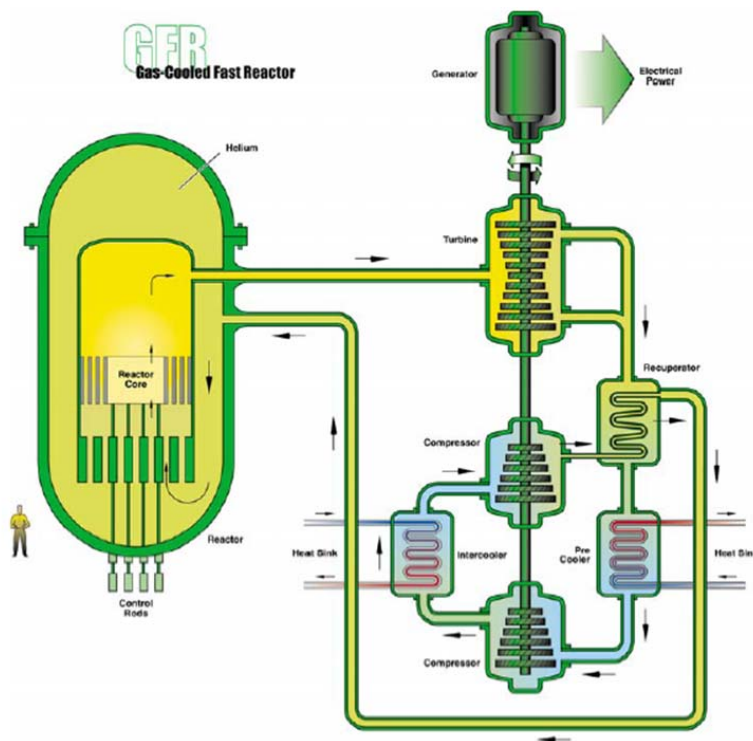

Reactor Parameters	Reference Value
Reactor power	600 MWth
Net plant efficiency (direct cycle helium)	48%
Coolant inlet/outlet temperature and pressure	490°C/850°C at 90 bar
Average power density	100 MWth/m <sup>3</sup>
Reference fuel compound	UPuC/SiC (70/30%) with about 20% Pu content
Volume fraction, Fuel/Gas/SiC	50/40/10%
Conversion ratio	Self-sufficient
Burnup, Damage	5% FIMA; 60 dpa

# The Gen IV GFR system



- High temperature, inert coolant and fast neutrons for a closed fuel cycle
  - Fast spectrum enables extension of uranium resources and waste minimization
  - High temperature enables non-electric applications
  - Non-reactive coolant eliminates material corrosion
- Very advanced system
  - Requires advanced materials and fuels
- Key technical focus
  - SiC clad carbide fuel
  - High temperature components and materials
  - Decay heat removal in accidental conditions



# Cut-away view of a proposed 2400 MWth indirect-cycle GFR

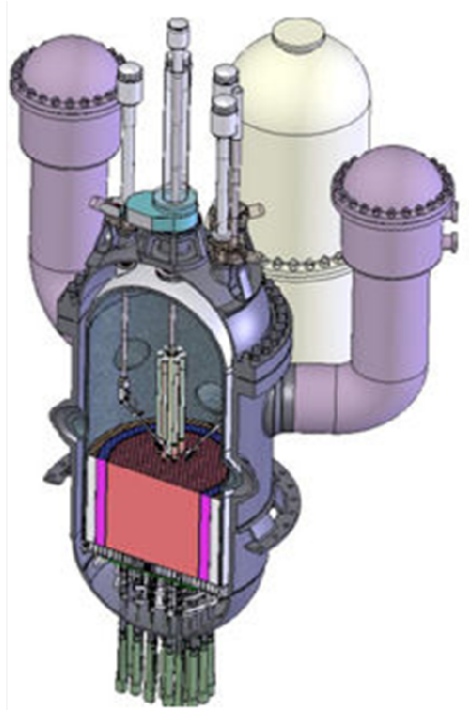

GFR - reactor, decay heat loops, main heat exchangers and fuel handling equipment

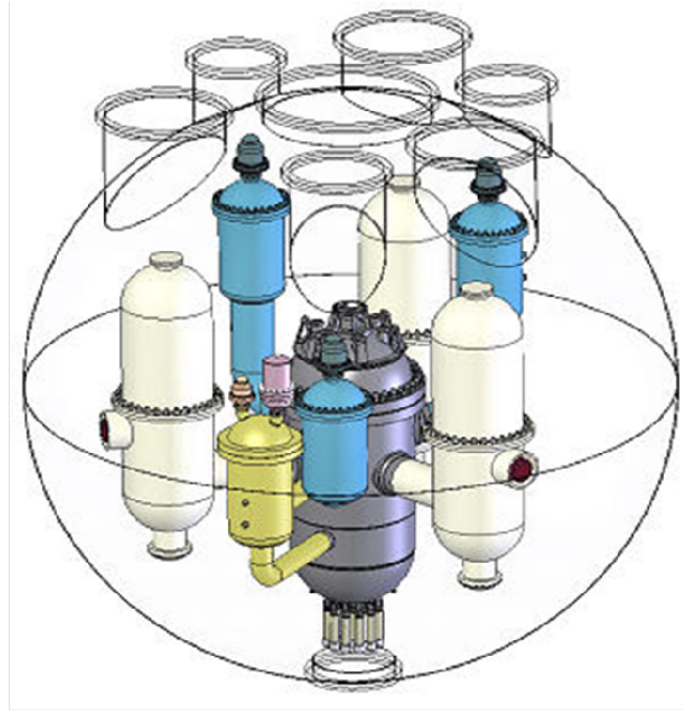

GFR - spherical guard vessel

# GFR Performance requirements



- Self-generation of plutonium in the core to ensure uranium resource saving.
- No fertile blankets to reduce the proliferation risk
- Limited mass of plutonium in the core to facilitate the industrial deployment of a fleet of GFRs.
- Ability to transmute long-lived nuclear waste resulting from spent fuel recycling, without lowering the overall performance of the system.
- Favorable economics owing to a high thermal efficiency and diverse (non-electricity) uses of high-quality heat.
- The proposed safety architecture fits with the objectives considering the following:
  - Control of reactivity by limiting the reactivity swing over the operating cycle;
  - Reduced coolant void reactivity.
  - Capacity of the system to cool the core in all postulated situations, provision of different systems (redundancy and diversification).
  - A “refractory” fuel element capable of withstanding very high temperatures (robustness of the first barrier and confinement of radioactive materials).

# Challenges: Core and Fuel



- The greatest challenge facing the GFR is the development of robust high temperature, high power density refractory fuels and core structural materials,
  - Must be capable of withstanding the in-core thermal, mechanical and radiation environment.
  - Safety (and economic) considerations demand a low core pressure drop, which favors high coolant volume fractions.
  - Minimizing the plutonium inventory leads to a demand for high fissile material volume fractions.
- Candidates for the fissile compound include carbides, nitrides, as well as oxides.
- Preferred cladding materials are SiC-SiCf

# Challenges: Materials, Components, He Technology



- High temperature corrosion resistant materials (cooling circuit, heat exchanger, insulation, sealing)
- Relatively high pressure in primary circuit & related highly efficient circulators
- Rapid heat-up of the core following loss-of-forced cooling due to:
  - Lack of thermal inertia (gaseous coolants & the core structure)
  - High power density (100 MW/m<sup>3</sup>)
- Relatively high temperature non-uniformities along fuel rods
- Difficult decay heat removal in accident conditions (LOCA)
- High coolant velocity in the core (vibrations)
- He leakage from the system, He recycling & He chemistry control

# Fuel

- (U,Pu)C fuel
- SiC fibre-reinforced SiC cladding.
- An internal refractory metal liner is required to prevent diffusion of fission products through the SiC/SiCf cladding or flow of fission products through micro-cracks.

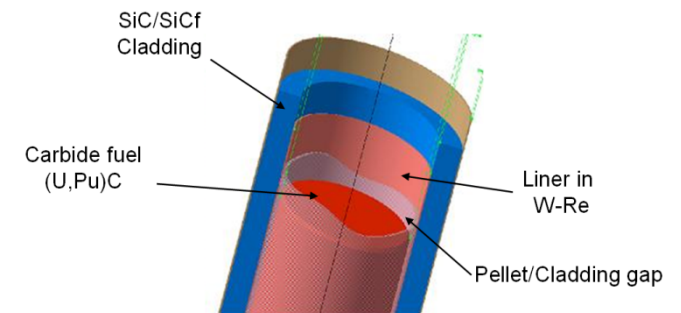
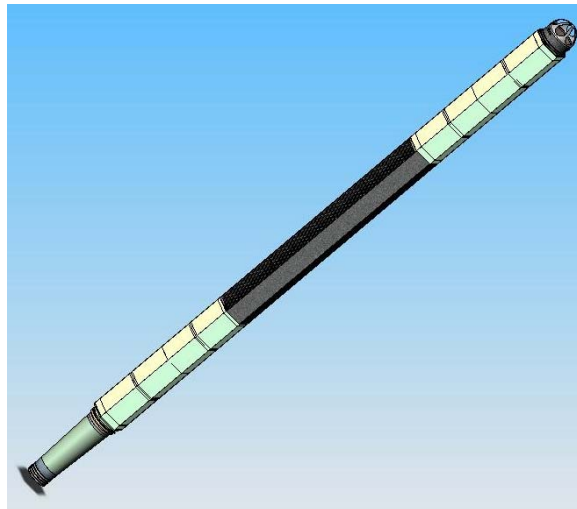
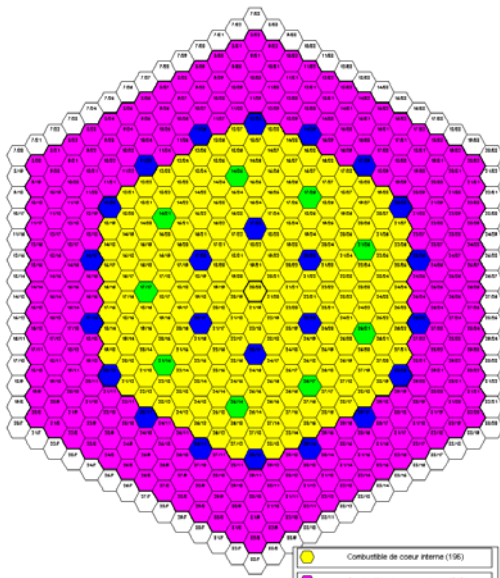

# Decay Heat Removal



- HTR “conduction cool-down” will not work in a GFR
  - High power density, low thermal inertia, poor conduction path and small surface area of the core conspire to prevent conduction cooling.
- A convective flow is required through the core at all times;
  - Under pressurized conditions natural convection can be efficient enough
  - Under depressurised conditions the challenges are:
    - Natural convection efficiency due to the very low gas density.
    - Power requirements for the blower are very large at low pressure
    - Back-up pressure (guard vessel) is needed
- The primary circuit must be reconfigured to allow DHR
  - Main loop must be isolated
  - DHR loop(s) must be connected across the core

# Decay Heat Removal

Passive heat conduction paths and power densities for GT-MHR and GFR2400 cores

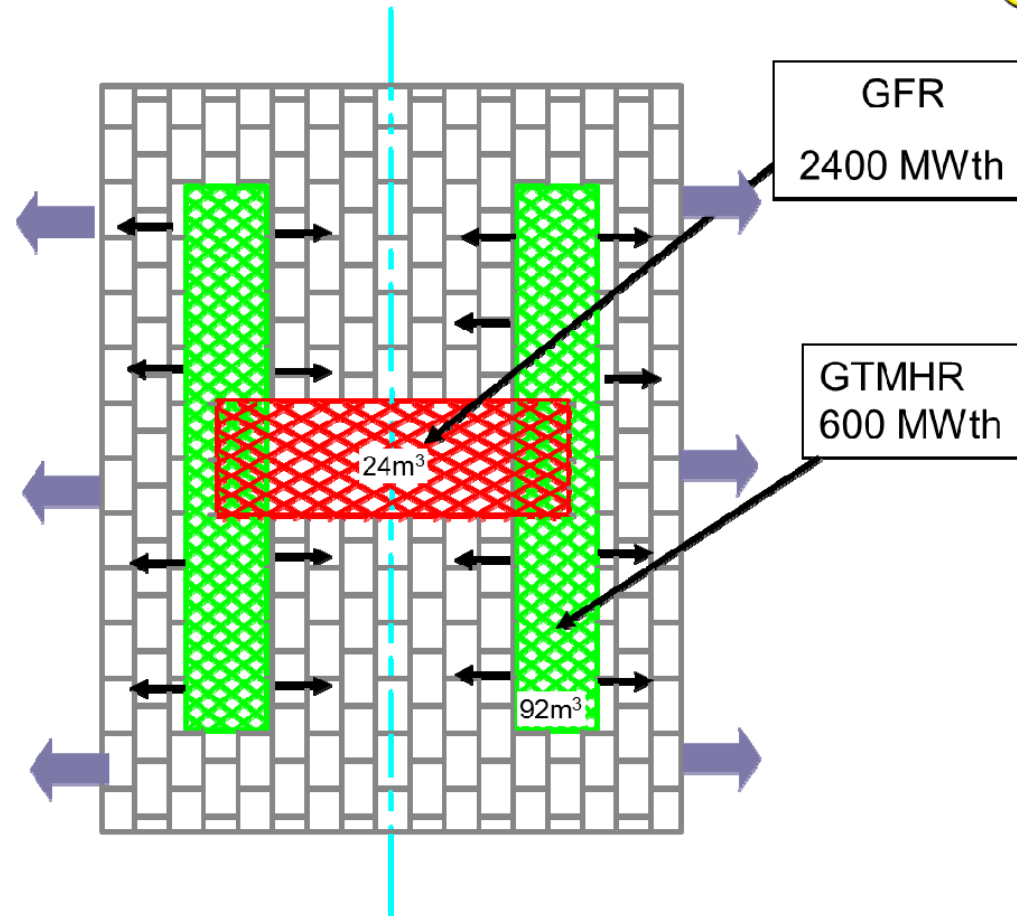

# Decay Heat Removal

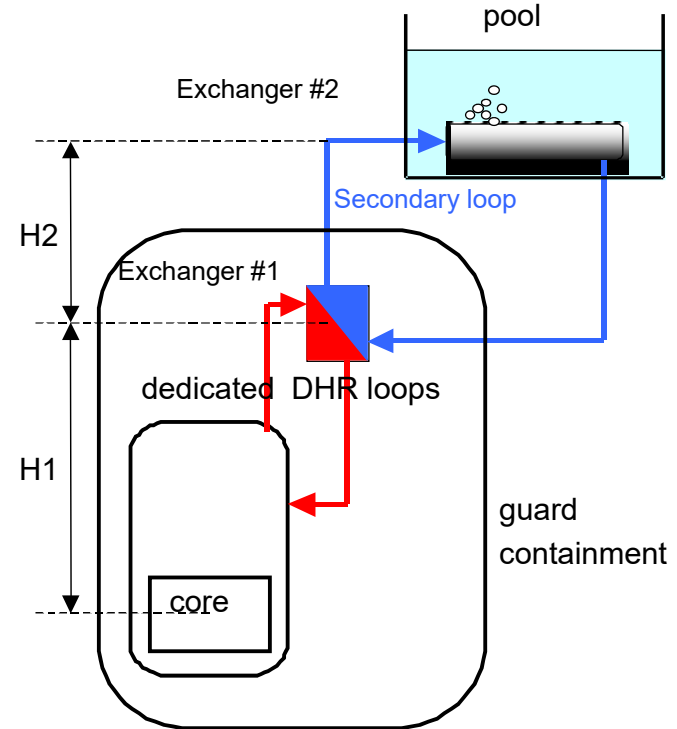
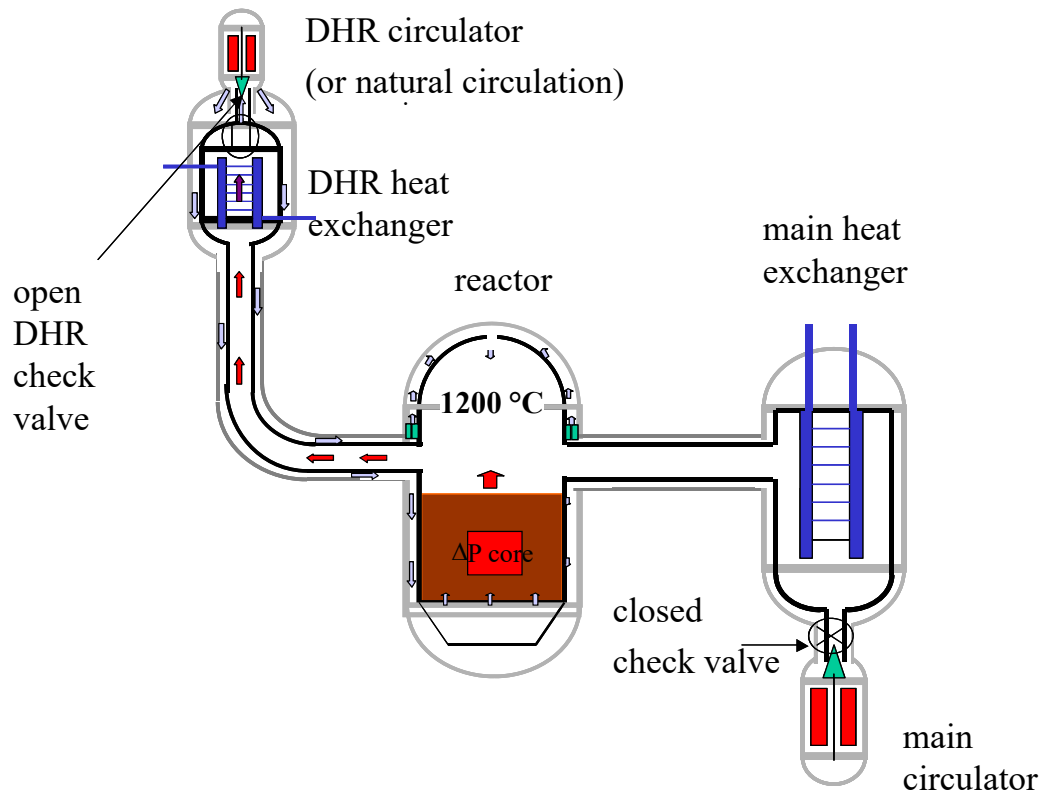



# Materials: Reactor Pressure Vessel



## Requirements

- Long term aging and structural integrity (60years)
- Industrial feasibility: manufacturability & weldability
- Environmental effects (impure He compatibility) on oxidation, fatigue, fatigue crack growth at very high temperature (incl. accidental conditions)
- Tensile and very long term creep and creep-rupture properties of the plate, forging, weldments, and heat-affected zones of this class of materials (operating T 400-550°C, 100 dpa)
- High temperature bolting (IN718; SS 304; SS 316)

## Candidate materials RPV:

- 9Cr1Mo-T9; 9Cr2Mo; 9Cr-MoVNb-T91; 9Cr-0.5Mo1.8WVNb-T92; 12Cr-1Mo-1WVNb-HCM12
- Reference material: 316LN

# Materials: High Temperature Components



## ▪ Requirements

- High thermomechanical resistance (temperature 850°C & pressure 7MPa)
- Good tensile, fatigue characteristics and long-term creep resistance
- Resistance to extreme environments – corrosion/oxidation in impure helium; H<sub>2</sub> and He embrittlement
- Industrial feasibility: manufacturability & joining techniques & compactness

## ▪ Intermediate Heat Exchanger:

- High thermal efficiency (95%), low pressure drop, no leakage, easy to inspect.

## ▪ Thermal insulation, sealing materials

- Safety thermal shield; reflector
- Candidate materials:
- C/C composites; SiC/SiC composites; Al<sub>2</sub>O<sub>3</sub>-SiO<sub>2</sub> ceramic fiber material; Zr<sub>3</sub>Si<sub>2</sub>

# Current R&D on materials

- Regulatory and Codification Requirements, development of codes, norms and methods
- Components Design, Testing and Fabrication issues (joining & post-weld treatment)
- Irradiation damage (RPV, internals, fuel assembly)
- Corrosion/oxidation/erosion resistance of selected materials
  - long term exposure tests
- Thermal aging; thermal shock degradation of fuel
- Design & Modeling work – mechanical properties
- Materials qualification and development  
F/M steels, **HT materials (Ni-alloys)**, ceramics

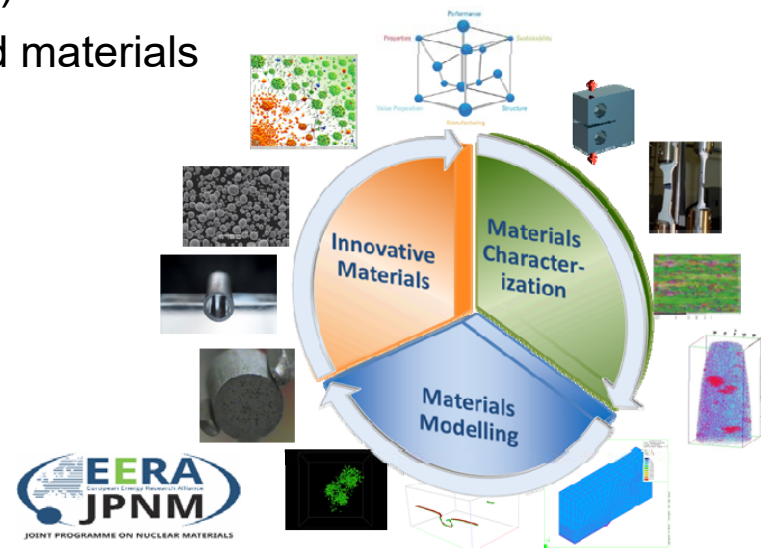

# ALLEGRO



## Projects of the European Sustainable Nuclear Industrial Initiative (ESNII)

- **ALLEGRO**

Gas Fast Reactor (GFR)  
Slovakia

Consortium V4G4, Czech Republic, Hungary, Poland and Slovakia, associated with France



- **ASTRID**

Advanced Sodium Technical Reactor for Industrial Demonstration  
Sodium Fast Reactor (SFR)  
France

- **ALFRED**

Advanced Lead Fast Reactor European Demonstrator  
Lead Fast Reactor (LFR)  
Romania

# Present projects: ALLEGRO

A technology demonstration as a first gas-cooled fast reactor

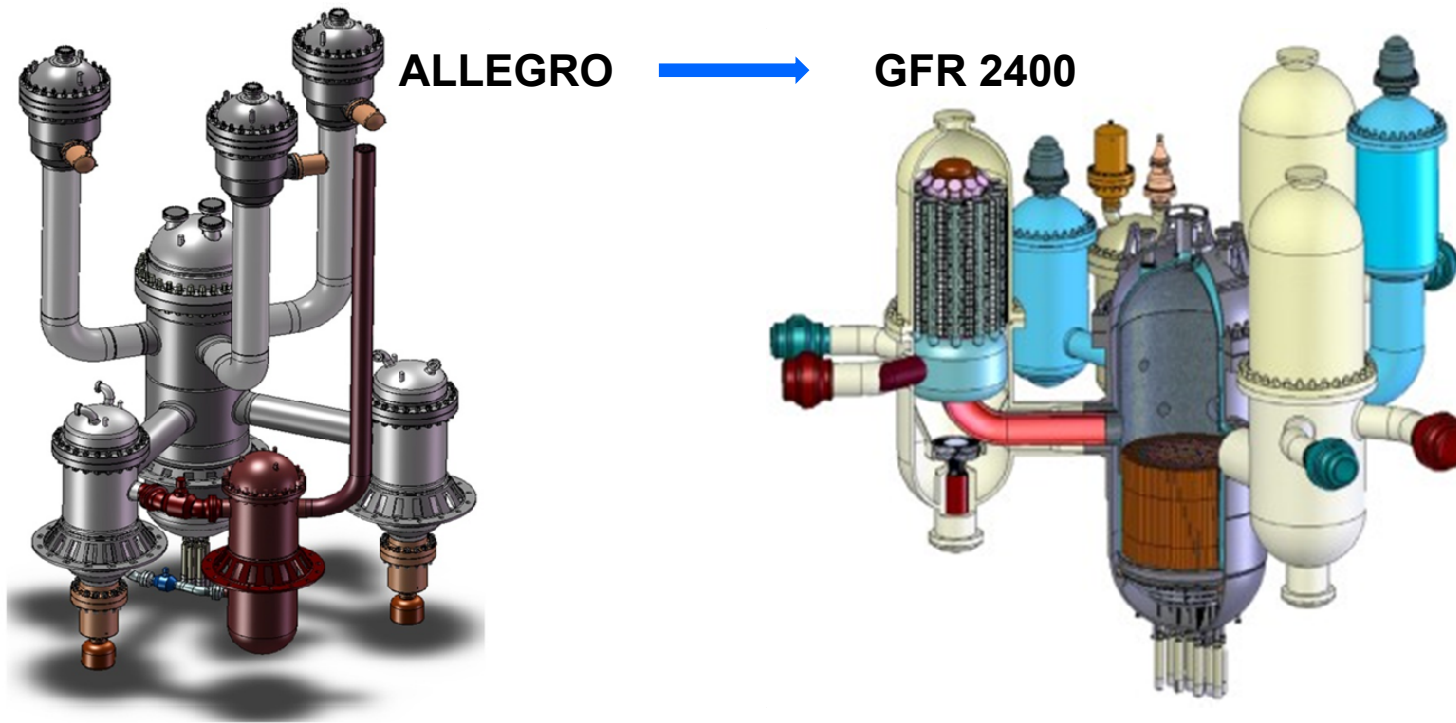

The objectives of ALLEGRO are to demonstrate the viability and to qualify specific GFR technologies.

# Objectives of ALLEGRO



- Demonstration of key GFR technologies:
  - Core behavior and control.
  - Development of ceramic fuels
  - Helium circuits and components
  - Decay heat removal
- Fast neutron irradiation capacity
- Potential for coupling with high temperature components or direct use of heat
- Development of safety standards for GFRs

# ALLEGRO

- 75 MWth nominal power
- Primary He (260-530°C core inlet-outlet, 70 bars)
- 2 Secondary pressurized water loops, option for an additional high temperature gas loop.
- Tertiary atmospheric air (No power conversion)
- 3 DHR loops (Primary He / Water HX)

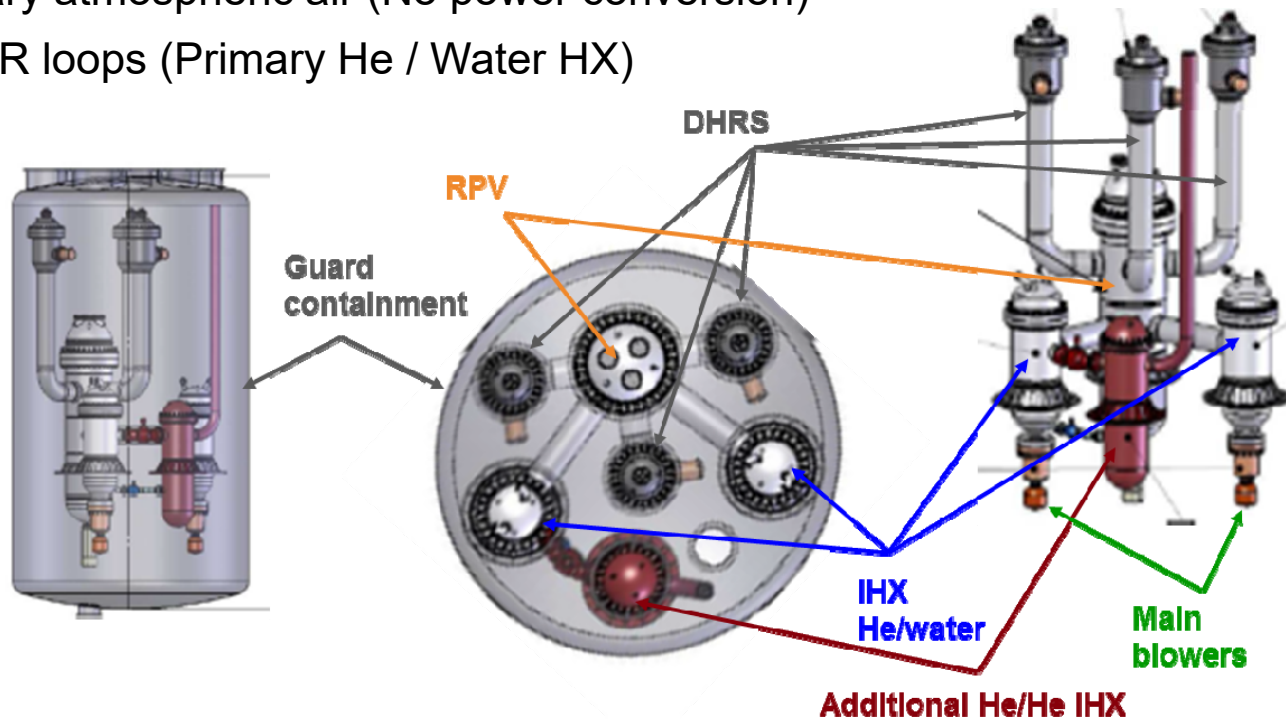

# ALLEGRO core

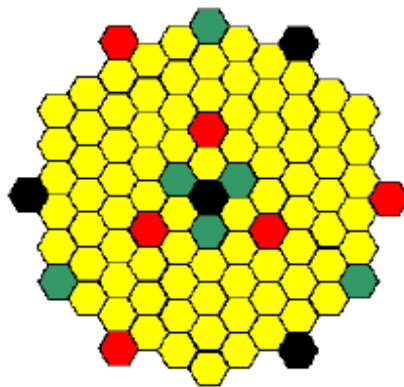
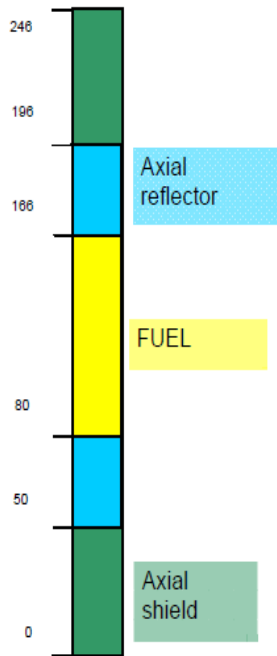

-  Experimental
-  MOX
-  Control
-  Shutdown

The reactor shall be operated with two different cores

- First core
  - Rely on already existing oxide fuel technologies.
  - Be used for the development of advanced GFR ceramic fuel by irradiation on some dedicated positions.
  - 75 MW, 100 MW/m<sup>3</sup>, 1 batch, 660 fped
  - Carbide experimental S/As
    - 8,4 10<sup>14</sup> n/cm<sup>2</sup>/s max fast flux (GFR2400 – 30%)
    - 1,8 at% max burn up (GFR2400 – 10%)
    - 15 dpa SiC max dose (GFR2400 – 32%)
- Long term core with ceramic fuel





	MOX Core	Ceramic Core
Core power		75 MWth
Coolant pressure		7 MPa
Primary mass flow rate	53 kg/s	36 kg/s
Core inlet temperature	260 °C	400 °C
Core outlet temperature	<b>560 °C</b>	<b>850 °C</b>



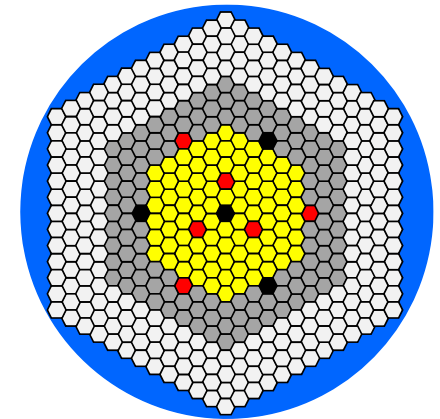

# ALLEGRO Reactivity control



-  87 MOX Fuel assemblies
-  4 Diverse Shutdown Devices
-  6 Control and Shutdown Devices
-  Reflector
-  Shielding

- The reactivity control is handled by two independent Control Rod Assemblies groups:
  - 6 Control and Shutdown Devices (CSD)
  - 4 Diverse Shutdown Devices (DSD)
- Each control rod and shutdown device is individually driven
- Control rods and shutdown devices mechanisms are disposed on the bottom of the reactor vessel.

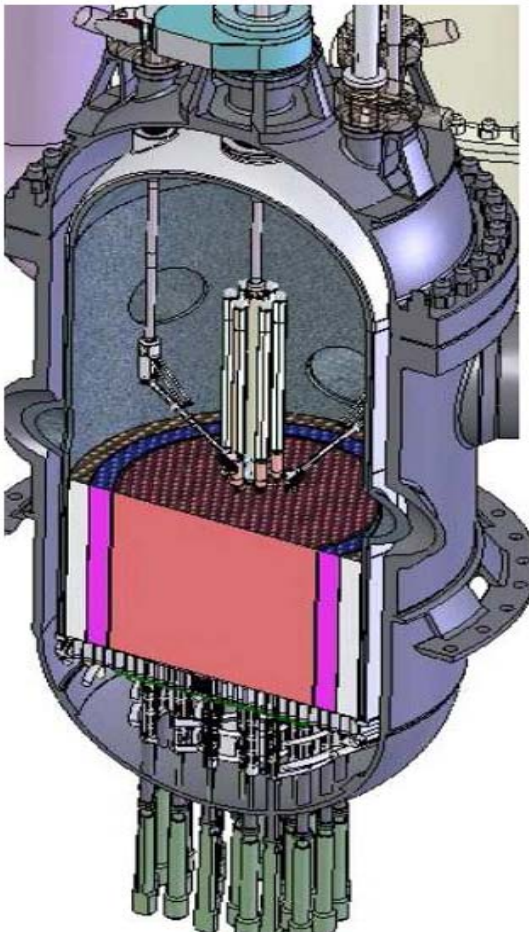

# ALLEGRO Decay Heat Removal

- The safety function of the decay heat removal system shall be to transfer fission product decay heat and other residual heat from the reactor core.
- The 3 x 100% DHR loop systems are designed to remove 3% of the nominal power (helium / water heat exchanger)
- DHR is located above the core to facilitate natural Helium circulation.
- DHR can operate in forced and natural circulation (challenging) if the DHR blowers are not be available.

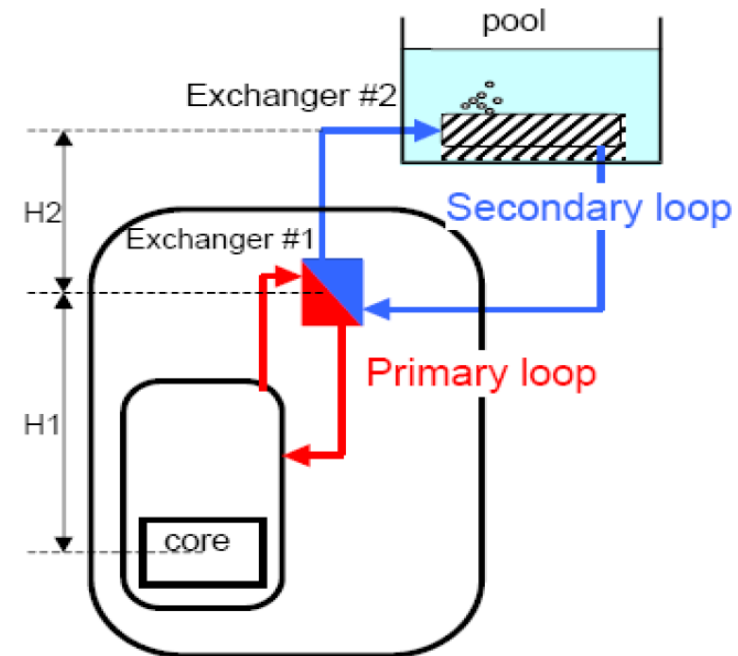

# Present projects: EM<sup>2</sup> General Atomics

## The Energy Multiplier Module, EM<sup>2</sup>, Is a Gas-Cooled Fast Reactor



- **Combination of advanced fuel and cladding enables revolutionary instead of incremental advances**
- **Reactor Design –**
  - vented fuel for > 20 yr life
  - higher temp allows for process heat applications and efficiency
- **Components take advantage of advanced materials–**
  - irradiation resistant SiC-SiC cladding
  - high uranium-bearing fuels

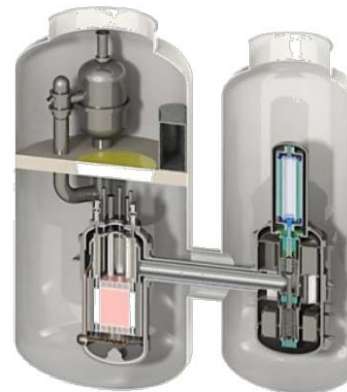

# Present projects: EM<sup>2</sup> General Atomics

EM<sup>2</sup> Fuel is Designed to  
Meet the Challenge of a 30-Year Burn

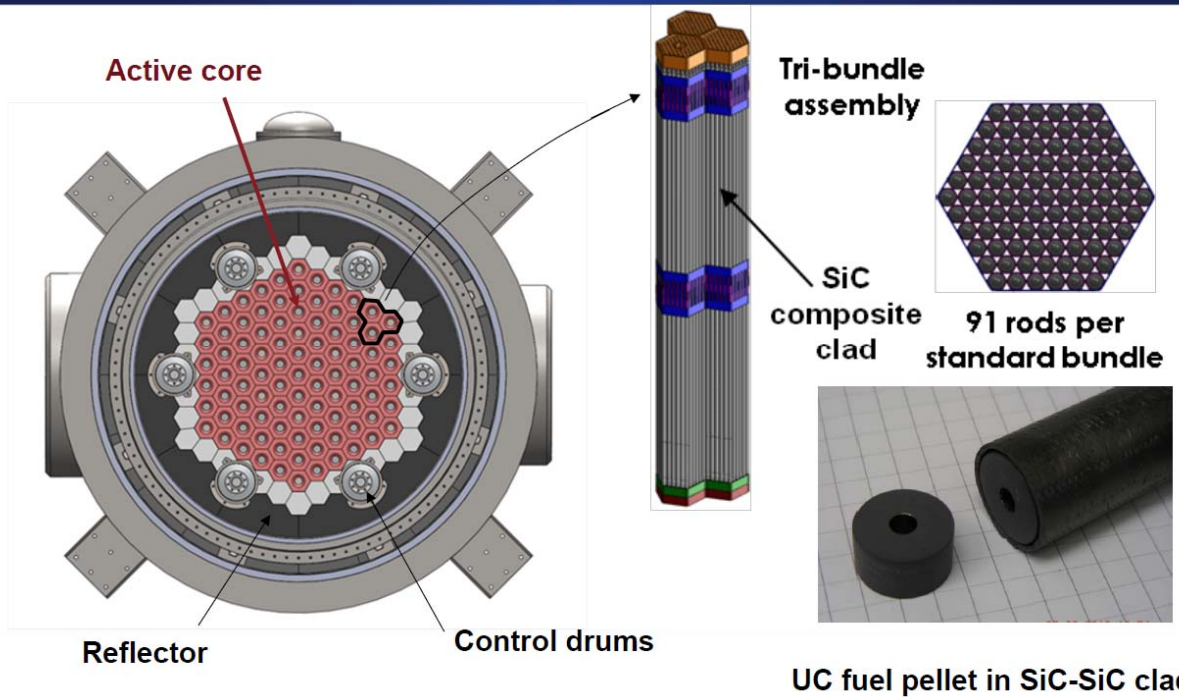

# Conclusions



- The GFR concept is attractive as it avoids the coolant related issues associated with liquid metal-cooled fast reactors:
  - Chemical inertness of helium
  - Excellent nuclear stability avoids activation of the coolant
  - Transparent coolant permits simple inspection and repair
- GFR offers a high temperature heat source for high efficiency electricity generation and high-quality process heat.
- The main technical challenges lie in the development of a high-temperature, high-power density fuel and in the development of robust decay heat removal systems.



# UPCOMING WEBINARS

28 March 2017	Supercritical Water Reactors	Dr. Laurence Leung, CNL, Canada
25 April 2017	Molten Salt Reactors	Dr. Elsa Merle, CEA, France
23 May 2017	Fluoride Cooled High Temperature Reactors	Prof. Per Peterson, UC Berkeley, USA