



## ON THORIUM AS NUCLEAR FUEL *GENERAL CONSIDERATIONS*

Dr. Franco Michel-Sendis  
OECD Nuclear Energy Agency  
July 12, 2017



Canadian Nuclear  
Laboratories

Laboratoires Nucléaires  
Canadiens



# Meet the presenter



Dr. Franco Michel-Sendis is responsible for the co-ordination of Nuclear Data Services and Criticality Safety Activities at the OECD Nuclear Energy Agency (NEA) under the Data Bank and the Nuclear Science Division, since 2010. From 2011 to 2016 he also served as NEA scientific secretary to the Generation IV Steering Committee for the Molten Salt Reactor System.

Dr. Michel-Sendis co-ordinated the 2015 NEA report “Introduction of Thorium in the Nuclear Fuel Cycle”.

Dr. Michel-Sendis holds a B.Sc and M.Sc in physics from the University of Paris (UPMC) and a Ph.D. in nuclear reactor physics from the University of Paris-Sud Orsay.



Email: [franco.michel-sendis@oecd.org](mailto:franco.michel-sendis@oecd.org)

## Thorium: Low *Signal-to-Noise Ratio* for the General Public at Least



- Many self-proclaimed “grass roots movements” advocating for thorium have appeared in recent years.
- Although sometimes well-intentioned they often address the general public with an oversimplified view of thorium as a miracle solution to the world’s energy problems, profiting from increased public concern about nuclear energy in a post-Fukushima context.
- Let’s bring back the debate to the scientific / industrial arena; Some elements are given in this webinar, albeit non exhaustively.

# Is Thorium a "new miracle solution?" Misconceptions abound in the General Media!

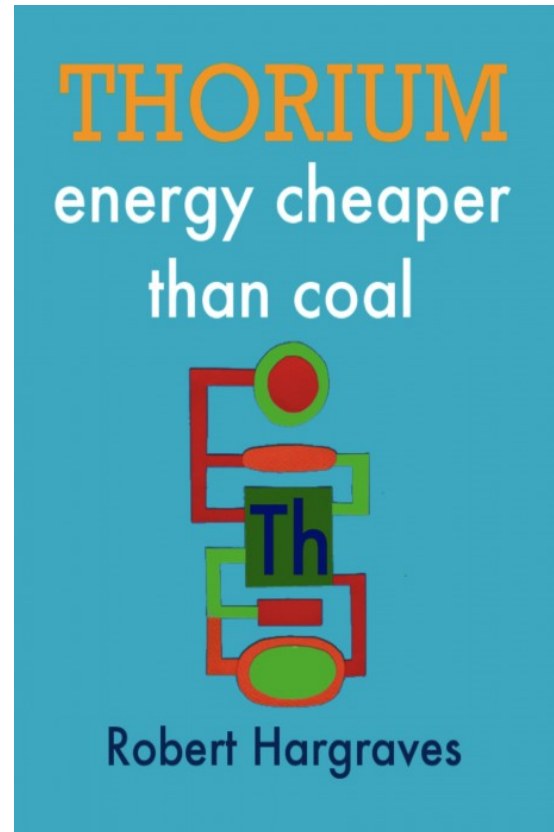
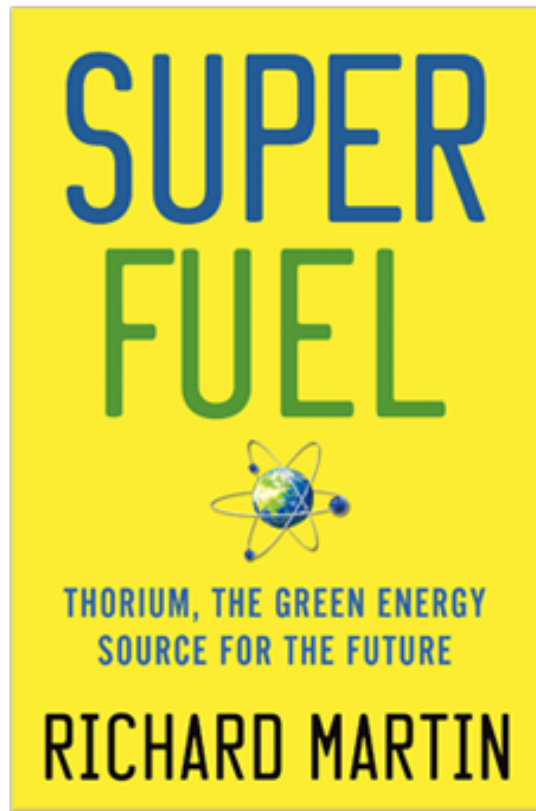

# Thorium : a *Trendy* Subject?

Google Trends – Worldwide monthly popularity of search term “Thorium” over time (% of maximum)

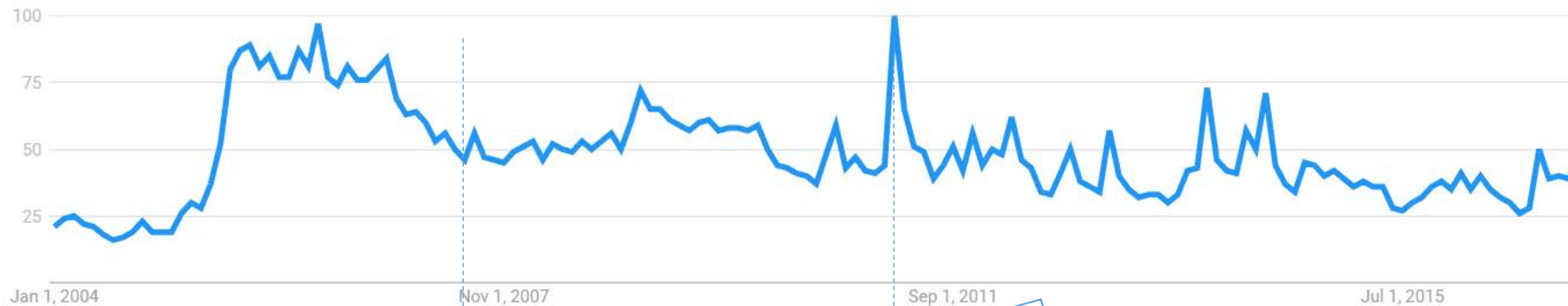

International Monetary Fund – Uranium (U3O8) spot price over time



# Scope

- *General background*
  - Neutronics / Nuclides, fissile / fertile nuclides and cycles
  - Fission basics, neutron economy, breeding
- *Historical context of Thorium development*
  - Brief examples on past experience
- *Brief and General Considerations on*
  - Resources
  - Reprocessing
  - Proliferation Resistance
  - Waste
- *Some Conclusions*

# At the beginning... The Universe

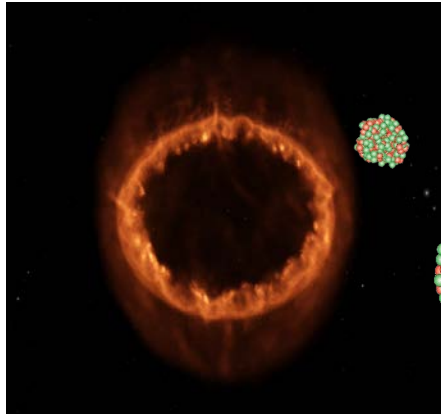

Supernova 1987A (simulation)  
Credits: NASA, ESA, and F. Summers and G. Bacon (STScI), S. Orlando (INAF-Osservatorio Astronomico di Palermo)

- Stellar Nucleosynthesis of Heavy elements ( $A > \sim 60$ ) ; *r*-process in supernovae, in particular for actinides

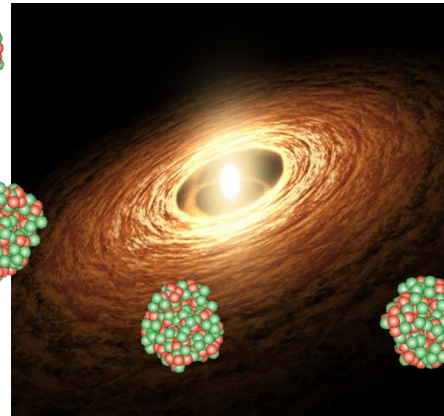

Sun-like star and accretion disk (illustration)  
Credits: NASA/JPL-Caltech/T.Pyle

- Primordial heat from Earth's formation and radioactive decay of **U**, **Th**, and **K** mostly responsible from Earth's internal heat

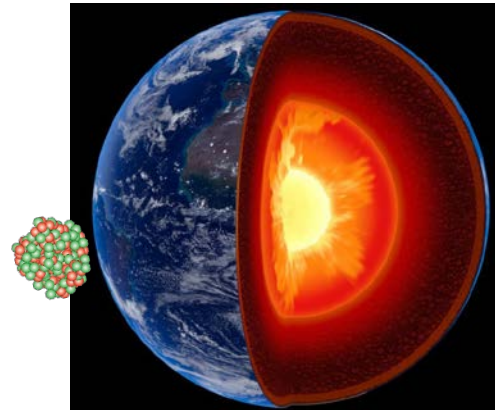

Structure of Earth's crust, mantle and core (illustration)

# Nuclide *bonanza*

Over 3300 nuclides known

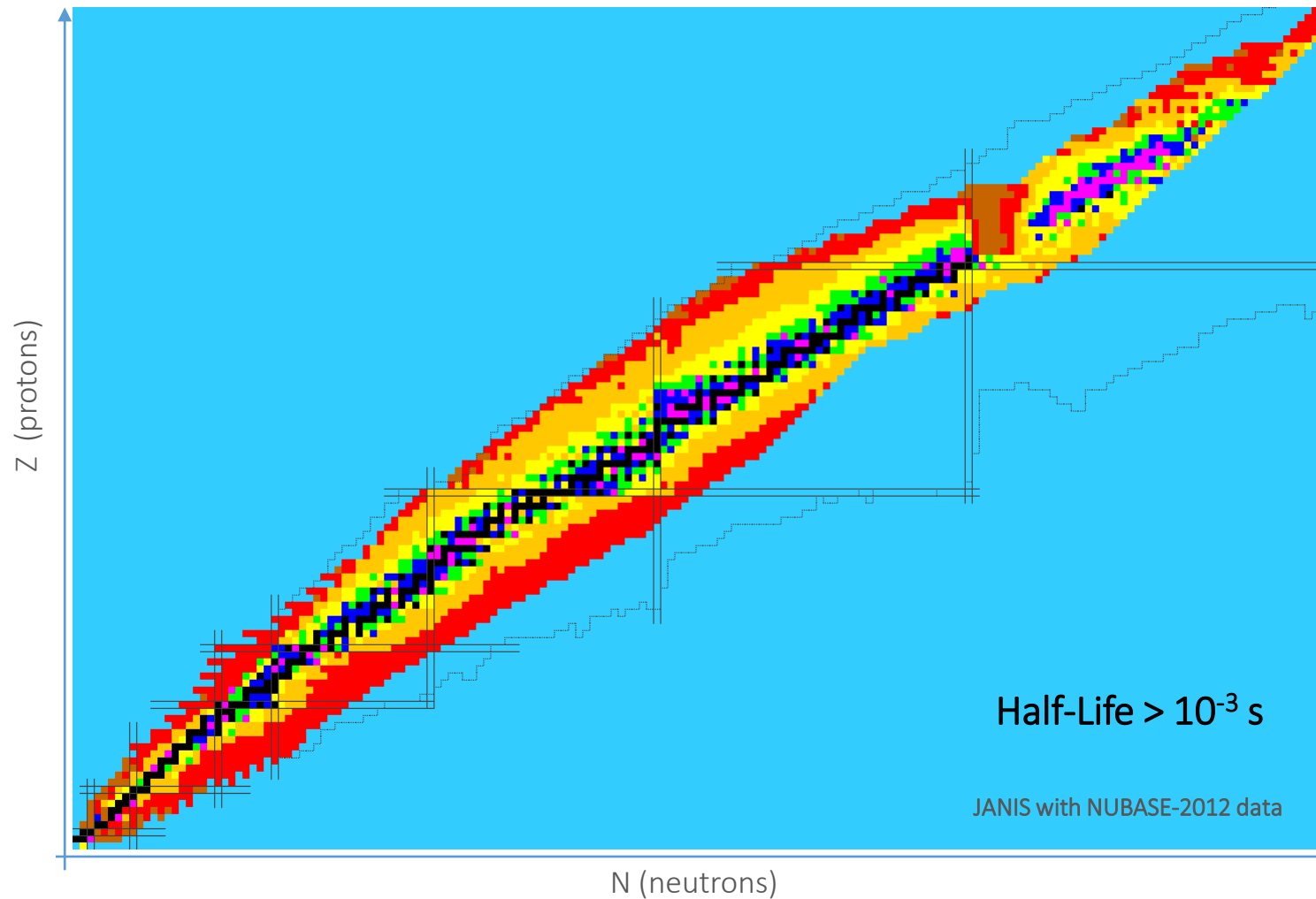



# Nuclide *bonanza* : Most nuclides are unstable

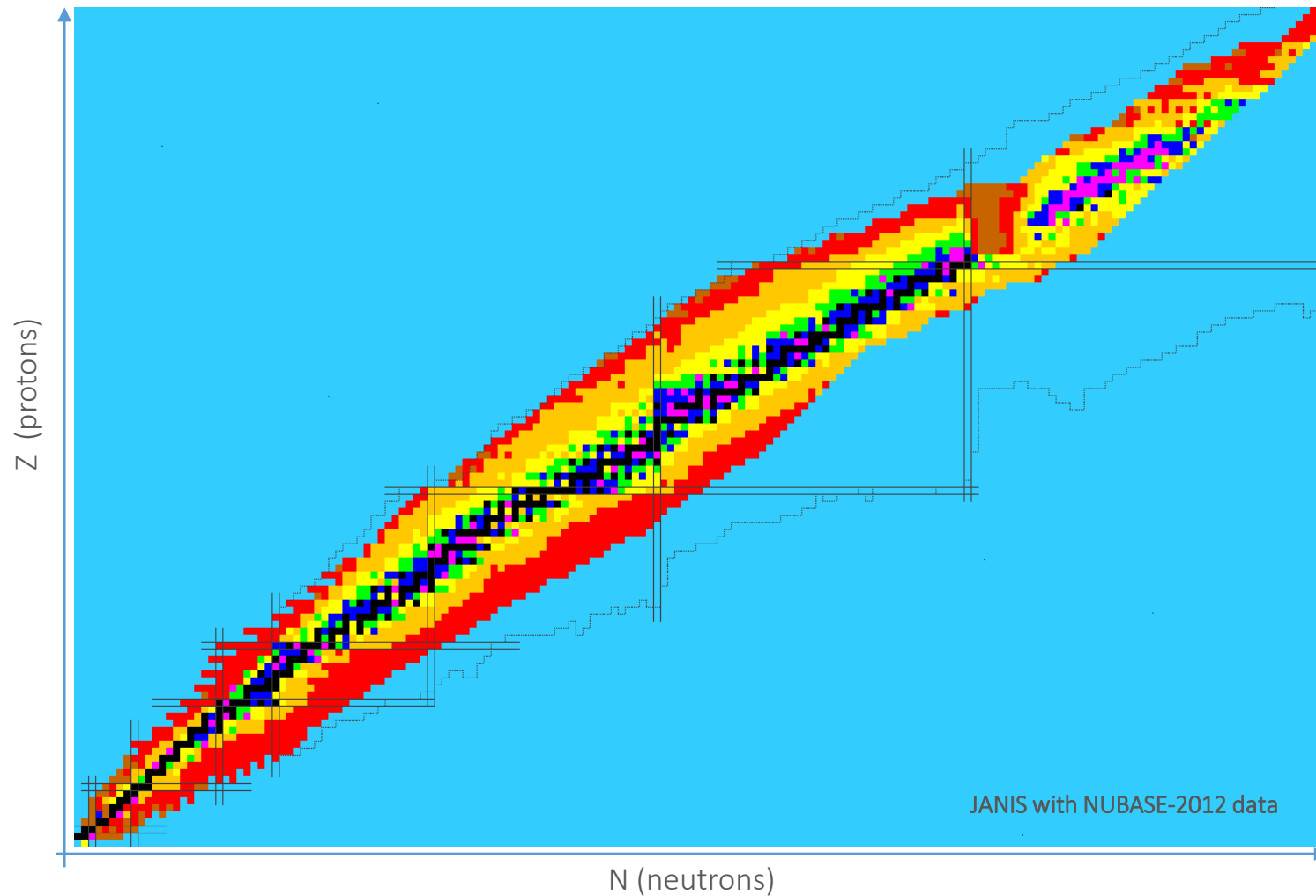

# Nuclear Fission: *Do not wait another billion years !*

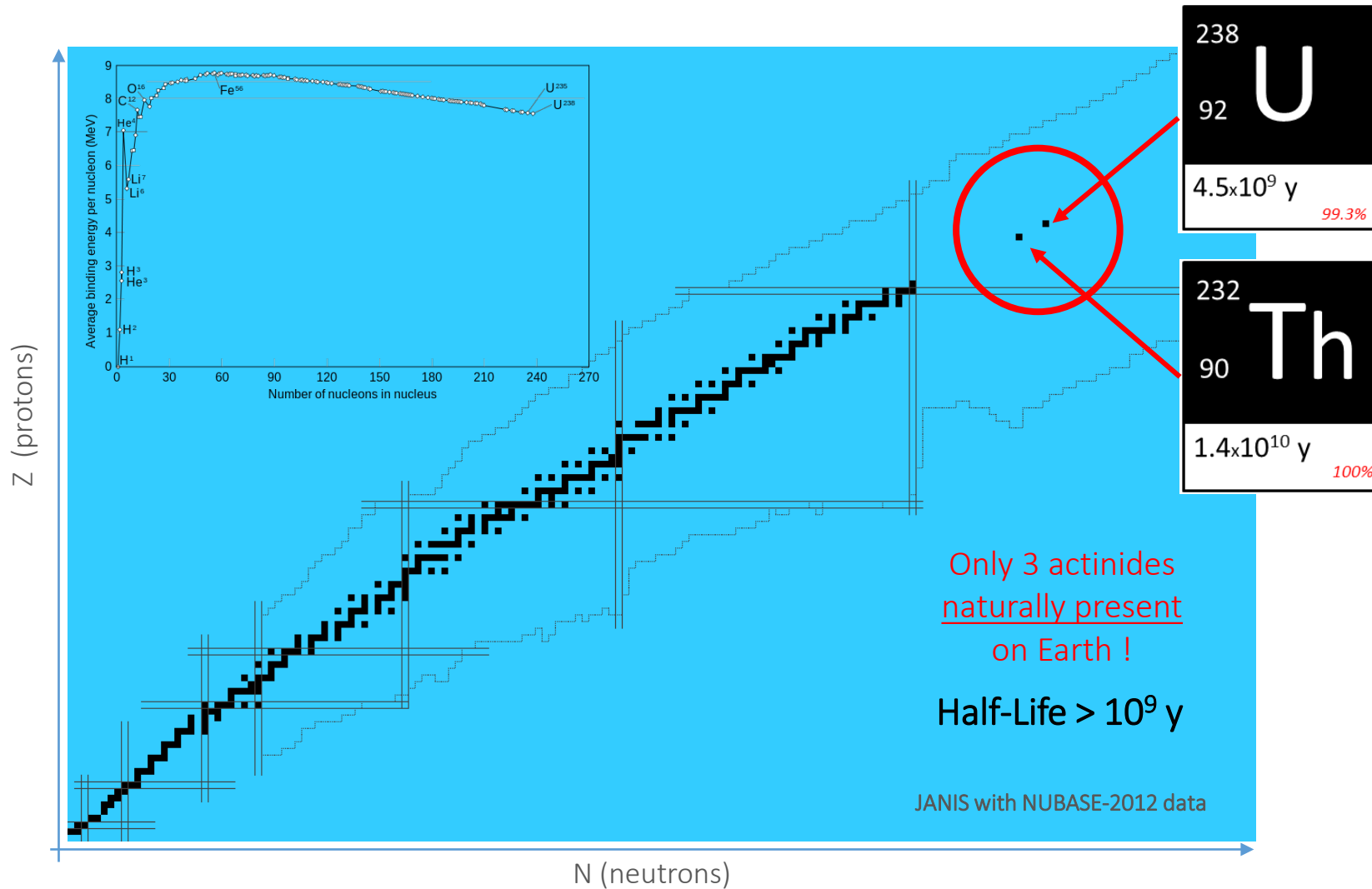

# Nuclear Fission: *Just in time !*

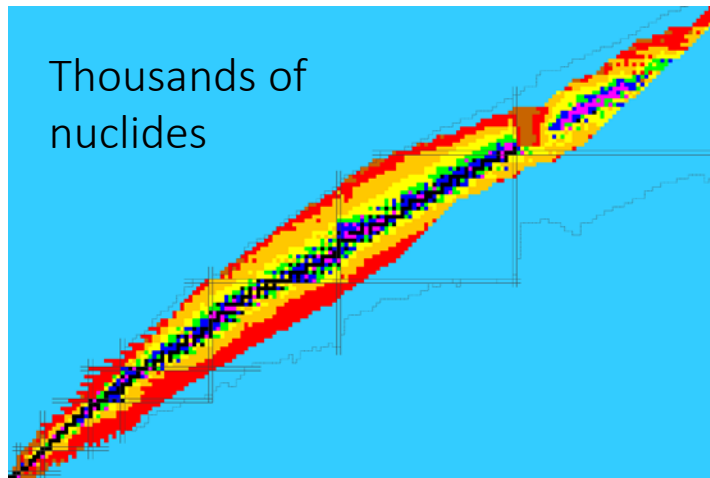

Only 1 *fissile* nuclide  
naturally present  
on Earth !

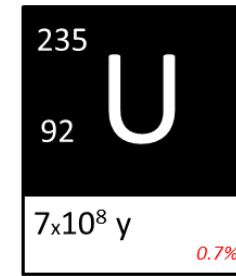

... and decaying

1972: CEA (France) discovered that self-sustaining nuclear chain reactions occurred on Earth about 2 billion years ago at the Oklo mine (Gabon)

$$U_{\text{Oklo}} \sim 0.5\% U_5$$

# Uranium-235 : the only possible “match” to start the nuclear industry



Natural Uranium Mineral :

$^{238}\text{U} = 99.3\%$

$^{235}\text{U} = 0.7\%$

Fertile

Fissile



Natural Thorium  
 $100\% \text{ } ^{232}\text{Th}$  Fertile

# U or Th ? Not that much of a choice in fact

- Only three actinides are naturally present on Earth
- Thorium is likely abundant
- But Thorium lacks a fissile isotope; **only <sup>235</sup>U is fissile**

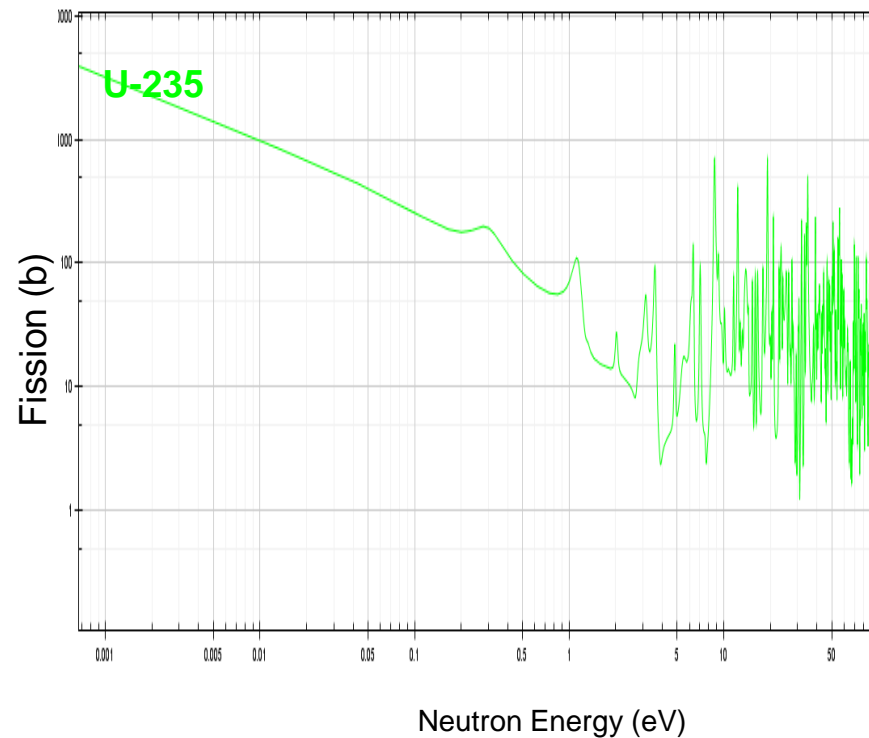
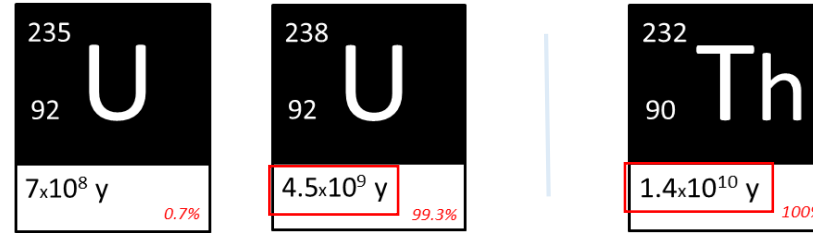

# U or Th ? Not that much of a choice in fact

- Only three actinides are naturally present on Earth
- Thorium is likely abundant
- But Thorium lacks a fissile isotope; **only  $^{235}\text{U}$  is fissile**

## Under neutron irradiation :

- $^{238}\text{U}$  will produce  $^{239}\text{Pu}$
- $^{232}\text{Th}$  will produce  $^{233}\text{U}$

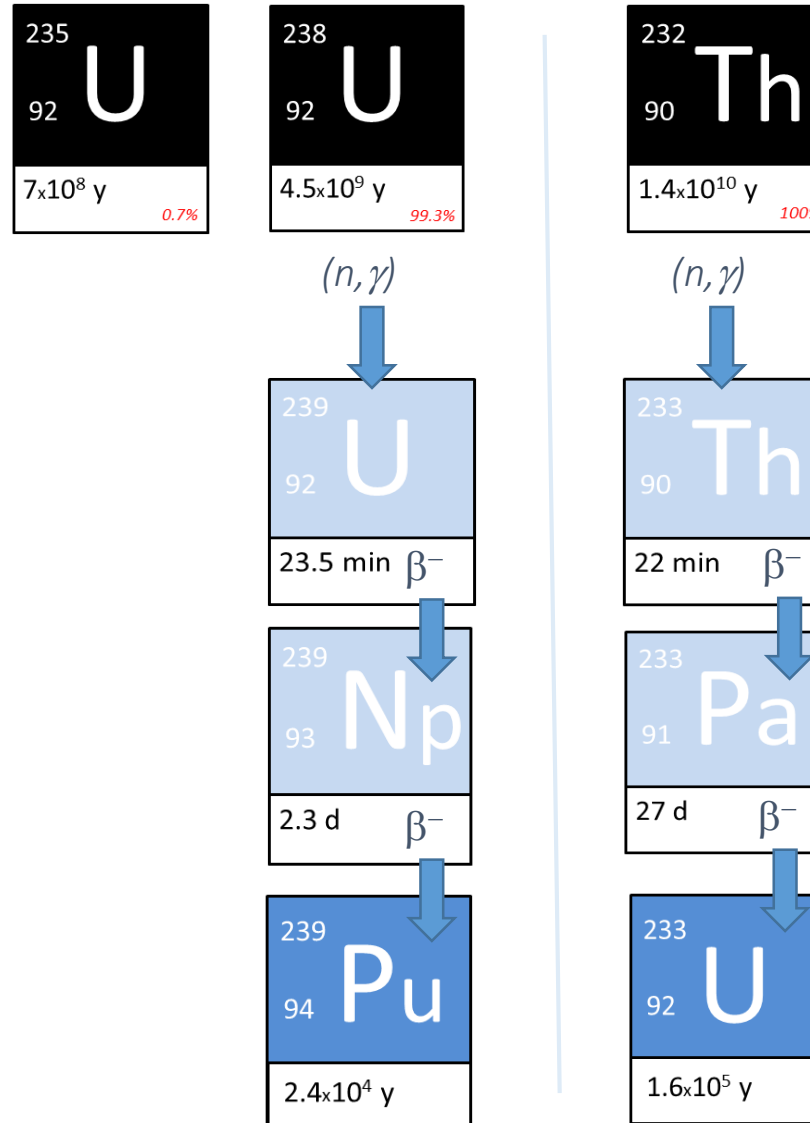

# Pa-233 : Keep it in mind !

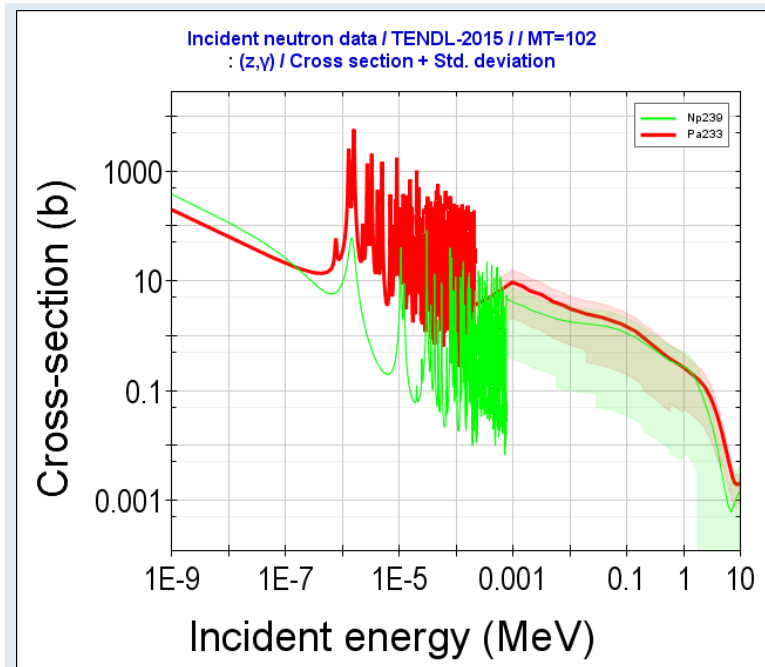

## Under neutron irradiation :

- $^{238}\text{U}$  will produce  $^{239}\text{Pu}$
- $^{232}\text{Th}$  will produce  $^{233}\text{U}$

Unless  $^{233}\text{Pa}$  captures a neutron and does not decay into  $^{233}\text{U}$

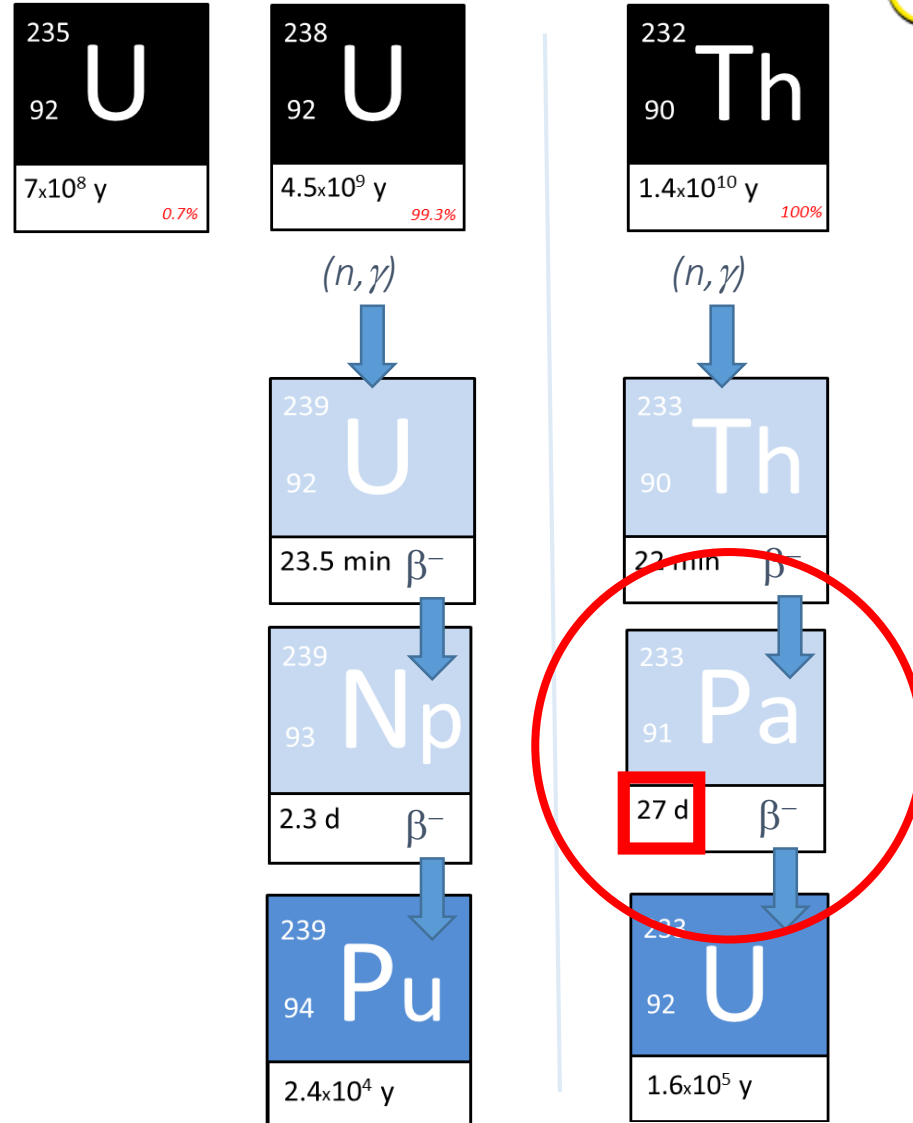

# U or Th ? Not that much of a choice in fact

- Only three actinides are naturally present on Earth
- Thorium is likely abundant
- But Thorium lacks a fissile isotope; **only  $^{235}\text{U}$  is fissile**

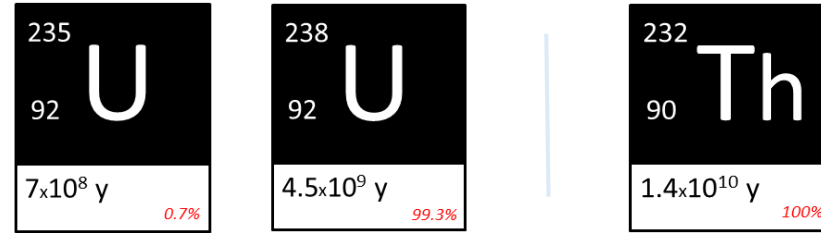

## Under neutron irradiation :

- $^{238}\text{U}$  will produce  $^{239}\text{Pu}$
- $^{232}\text{Th}$  will produce  $^{233}\text{U}$
  
- $^{232}\text{Th}$  excellent fertile
- $^{233}\text{U}$  excellent fissile (in harder neutron spectra)

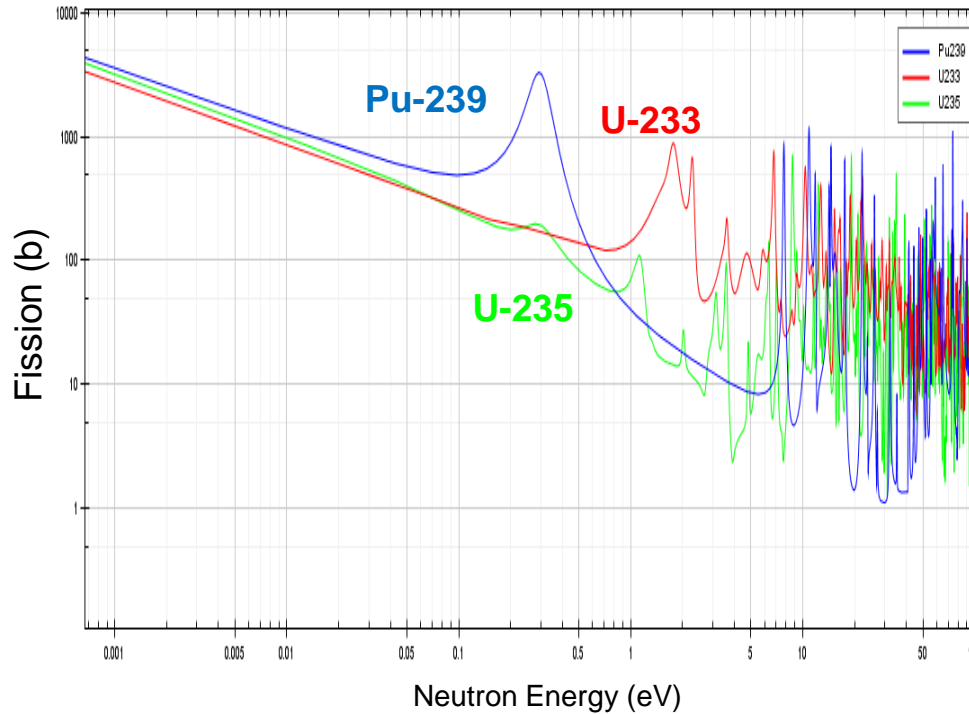



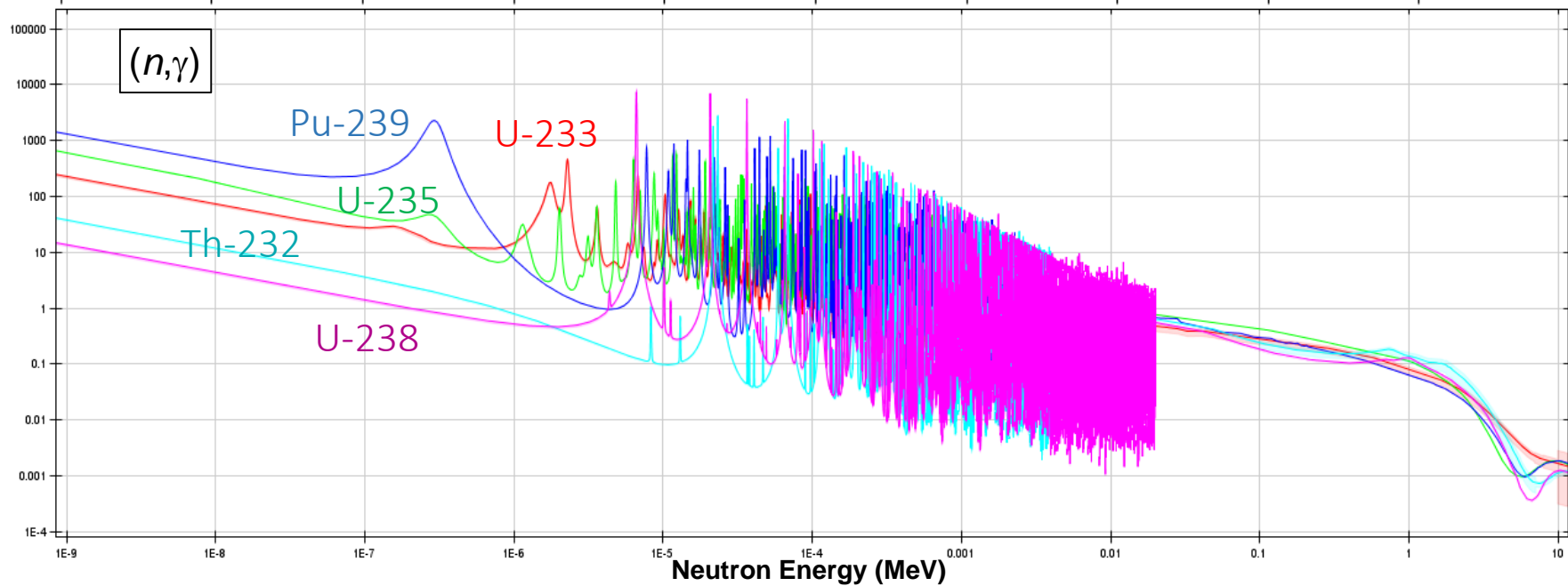
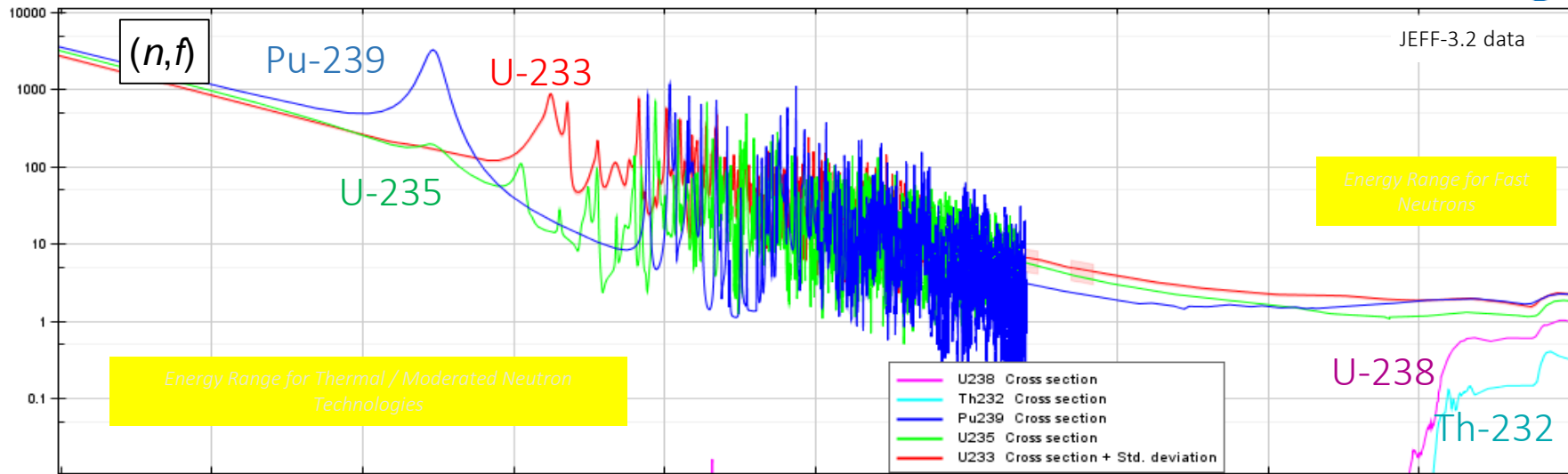

# Neutron-induced Fission

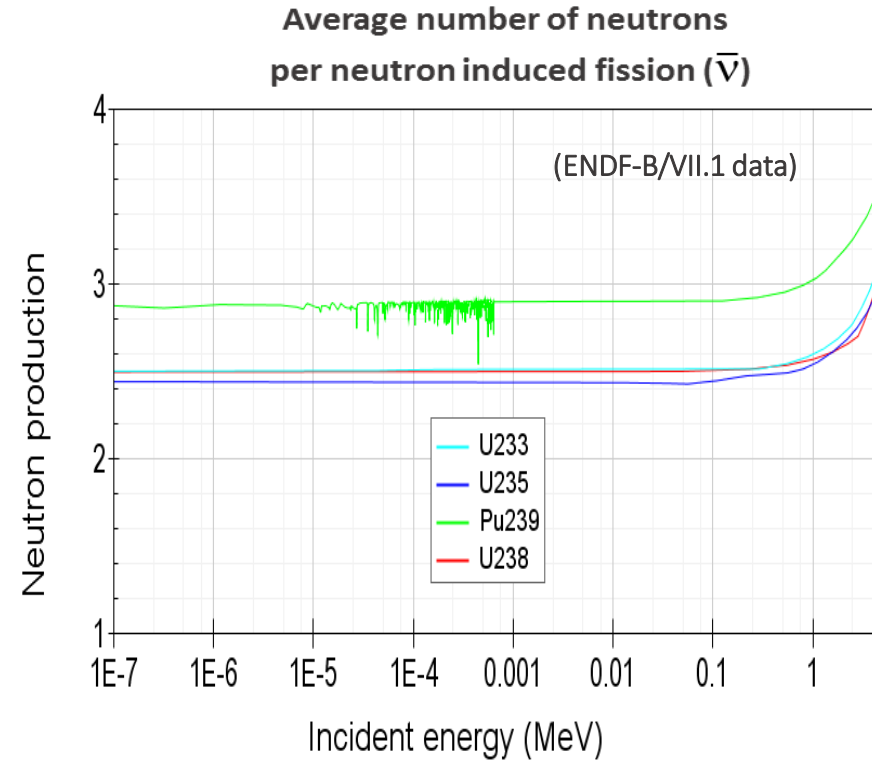
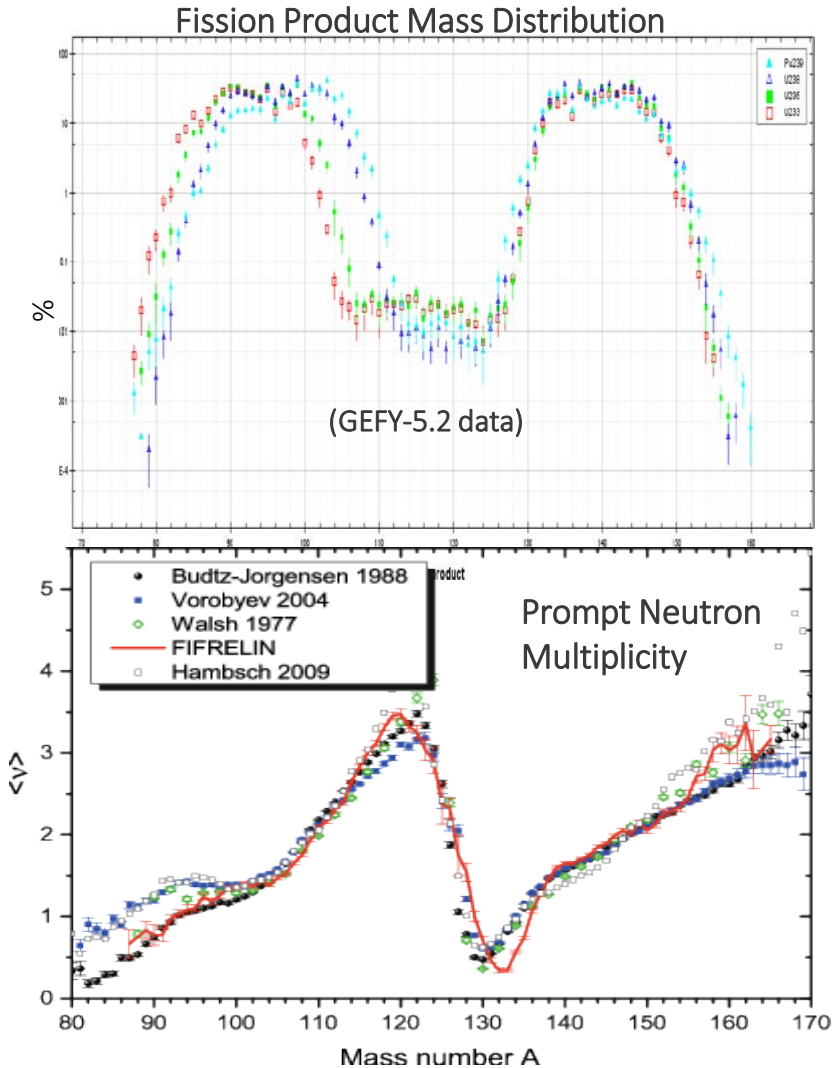

**$\bar{\nu} > 2 !$  : Huge implications**

## $\bar{\nu} > 2$ : Two immediate implications

1. A fission chain reaction is possible, a “pile” can be *critical* : a reactor
2. Even “breeding” could be possible if  $\nu - 2(1 + \alpha) > 0$  : a breeder reactor

Neutron economy remains very tight :

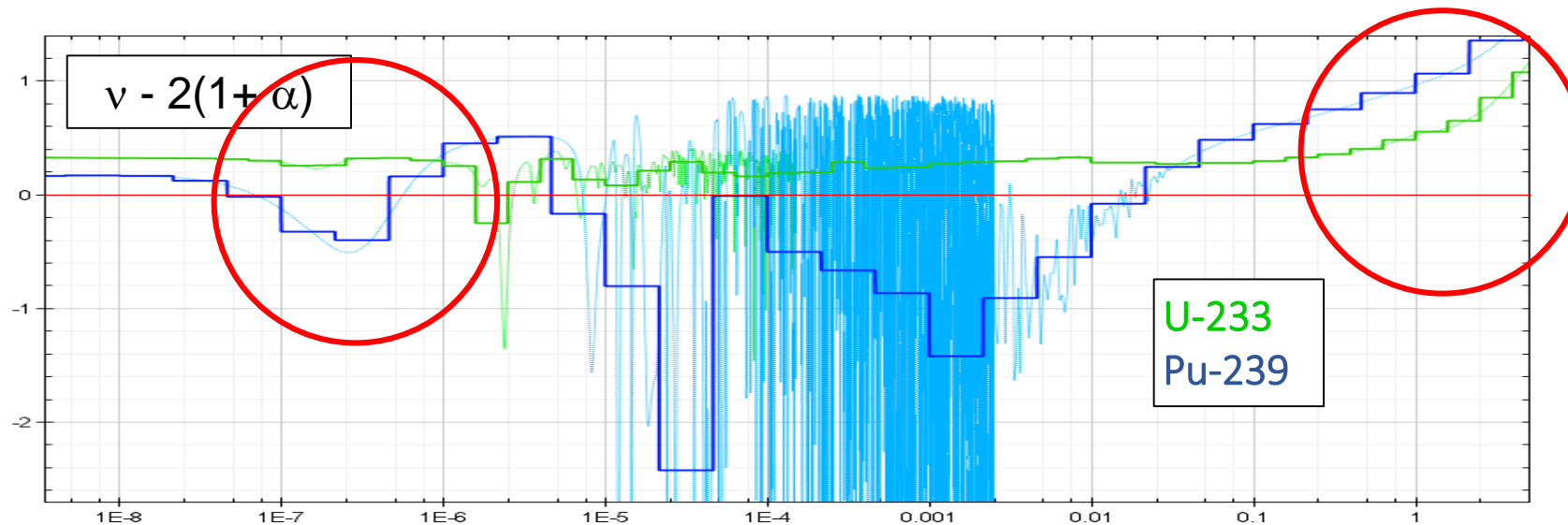

Breeding with Th-U233: possible in thermal spectrum  
U/Pu cycle : best neutron economy in fast spectrum

# “Napkin” Calculation Neutron Balance and Breeding

	Th-232/ U-233		U-238/Pu-239	
	Thermal	Fast	Thermal	Fast
Fission* (b)	529	1.91	784	1.79
Capture (fissile)* (b)	46.64	0.07	312	0.06
alpha	0.09	0.04	0.40	0.03
Neutrons per fission	2.49	2.53	2.85	2.94
Available for breeding	0.31	0.45	0.05	0.88

\* Maxwellian Thermal (25 meV) and Fission (1.25 MeV) average / JEFF-3.1.2 data

# “Napkin” calculation

## Concentration of fissile needed for breeding

Assuming Breeding: rate of neutron capture in fertiles = rate of losses of fissiles

$$N_{fertile} \sigma_{fertile}^{capture} \phi = N_{fissile} (\sigma_{fissile}^{capture} + \sigma_{fissile}^{fission}) \phi$$

Concentration of fissile for breeding ( $C_{fis}$ ) depends on average cross-sections values:

$$C_{fis} = \frac{N_{fis}}{N_{fis} + N_{fer}} \quad \longrightarrow \quad C_{fis} = \frac{\sigma_{fertile}^{capture}}{\sigma_{fertile}^{capture} + \sigma_{fissile}^{capture} + \sigma_{fissile}^{fission}}$$

Crude first approximation, but gives some orders of magnitude

# “Napkin” calculation Concentration of fissile if breeding

$$C_{fis} = \frac{\sigma_{fertile}^{capture}}{\sigma_{fertile}^{capture} + \sigma_{fissile}^{capture} + \sigma_{fissile}^{fission}}$$

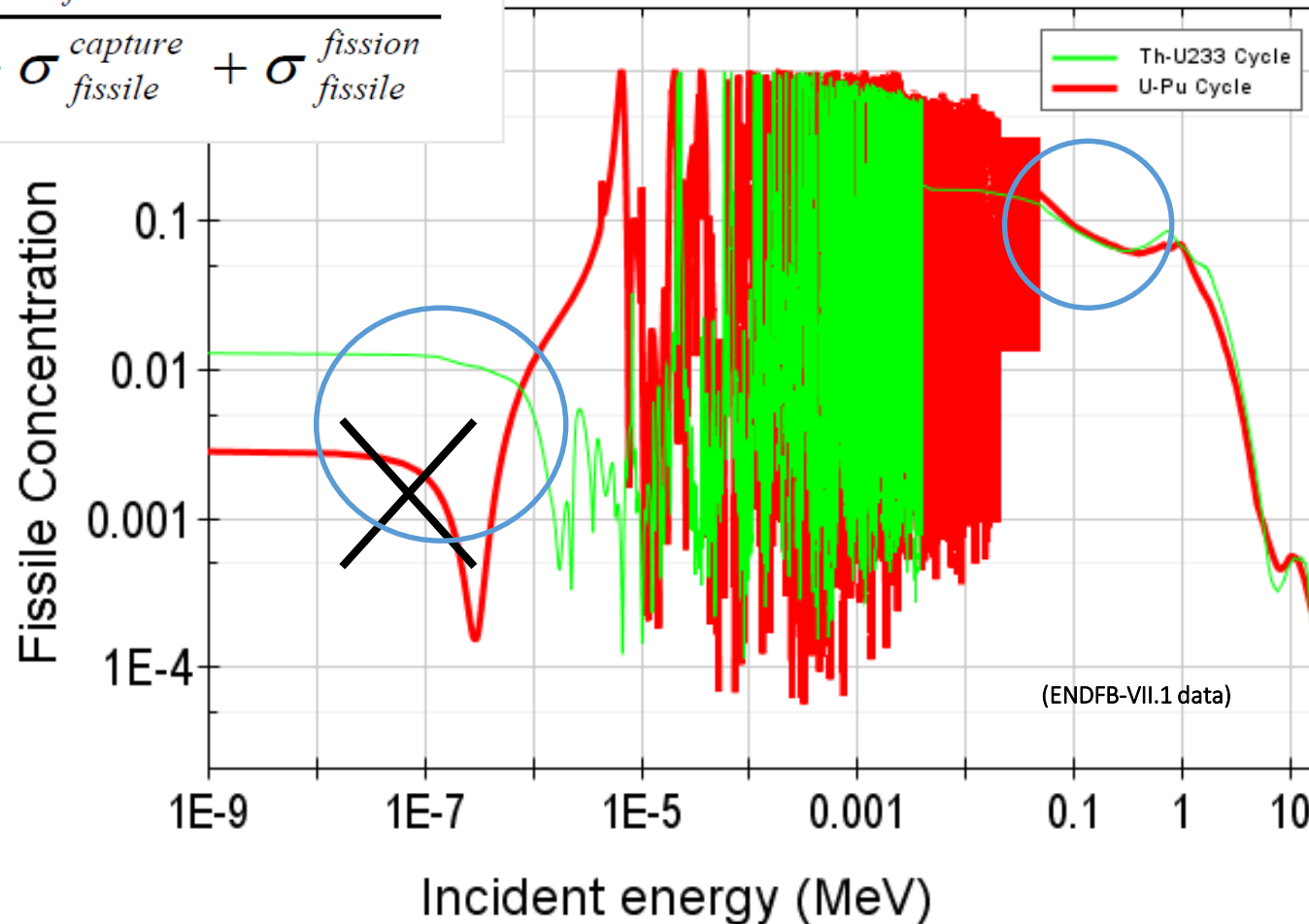

# “Napkin” calculation Concentration of fissile needed for breeding

	Th-232/ U-233		U-238/Pu-239
	Thermal	Fast	Fast
Fission * (b)	50	2.6	1.85
Capture (fissile)* (b)	6	0.27	0.5
Capture (fertile)* (b)	1.36	0.32	0.3
Fissile concentration	<b>2%</b>	10%	11%

*\* Average with simulated thermal and fast reactor spectrum*

Neutronics-wise: from a first glance, an potentially lower inherent fissile concentration (inventory) for Th/U breeder systems using thermal neutrons... provided all other technological and safety aspects allow it!

# Possibly a Thorium thermal breeder?

Why such a big deal ?

1. Thermal neutron technologies : existing technologies, better developed and more operational experience (at the time and still today, although today fast breeder reactors exist)
2. Because of the potentially lower initial fissile quantity needed to start a reactor:
  - Especially important if one must first breed  $^{233}\text{U}$  !
  - “Faster” deployment scenarios
3. At the time, uranium scarcity was feared, and thorium known to be likely abundant



# TI-208 : Strong gamma emitter

## Decay chain of Th-232 and U-232

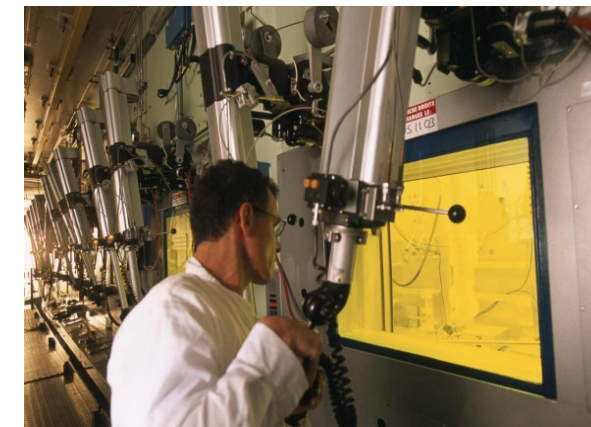
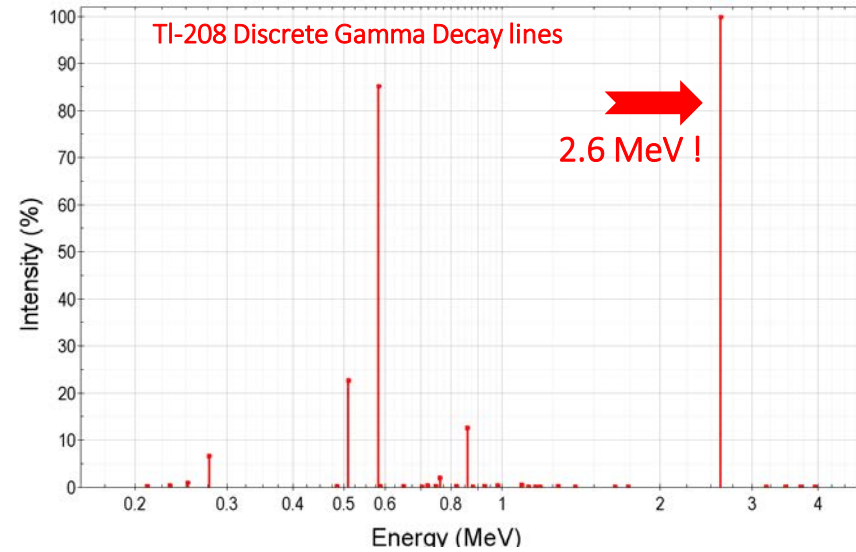
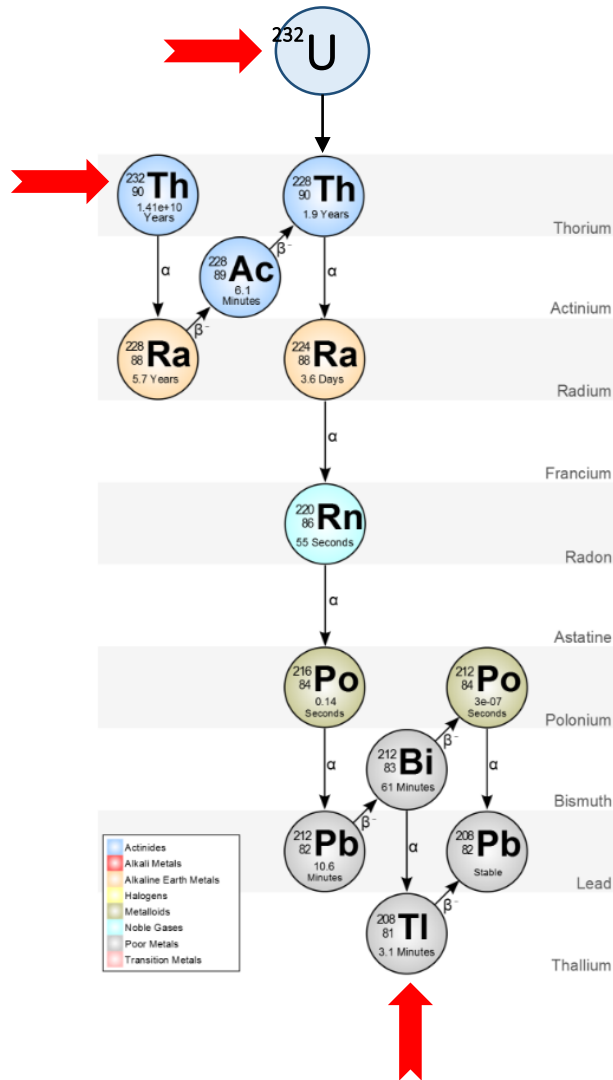

CEA Marcoule ATALANTE remote & shielded handling facility

# Is U-233 Proliferation Resistant ?

- An excellent fissile nuclide, U-233 is categorized under the same basis as plutonium (*IAEA Convention on the Physical Protection of Nuclear Materials*)
  - Claims that high U-232 content of Th/U233 fuel would be a proliferation deterrent (a hazard to terrorists and easily detectable) seems to be a weak proliferation claim, not a compelling argument
  - The degree to which this protects against proliferation depends on the threat scenario, the facilities available, the willingness of proliferators to expose themselves to radiation, and the availability of Th-232. Conversion of Th-208 to U-233 from Th-208 not guaranteed to cause rapid incapacitation
- It is rather a handling and shielding issue for fuel fabrication and processing
- Proliferation resistance of thorium cycles are more likely to be **comparable to U/Pu cycle**

**Incorrect to assert that the thorium fuel cycle is proliferation proof**

## Other Thorium Properties (Miscellanea)

ThO<sub>2</sub> ceramics over UO<sub>2</sub> :

- High melting point (~3300 Celsius vs 2800 celsius for UO<sub>2</sub>)
- Higher thermal conductivity resulting in lower fuel operating temperatures.
- Unlike UO<sub>2</sub>, ThO<sub>2</sub> is chemically stable; it does not oxidize when exposed to water/steam/air at high temperature,
- Higher FP retention in ThO<sub>2</sub> matrix
- These differences may translate into fuel performance improvements under normal operating conditions and in postulated accident scenarios.
- These differences will also translate into known difficulties at the reprocessing stage of thorium-based fuels, which are much more difficult to dissolve

# Thoria ( $\text{ThO}_2$ )-based fuels In current technologies

- Thoria-based fuels for LWRs and PHWRs exhibit improved defect performance (in terms of reduced fission product release and reduced erosion) and are a highly prospective technology for consuming or transmuting transuranic (Pu + MA) nuclides
- Thoria-based fuels must first be qualified to assure their safe performance in the usual suite of normal/accident scenarios; Processes will require significant further development and test programmes to manufacture and qualify optimal industrial thorium-based fuels.



**ThorEnergy @ IFE, Norway,  $(\text{Th}, \text{Ce})\text{O}_2$   
Irradiation tests at OECD Halden Reactor**

# Minor Actinide Production

- One often claimed advantages of the thorium cycle is that it produces less plutonium and other actinides which significantly reduce the radiotoxicity of waste.
- While a **pure Th/<sup>233</sup>U cycle** will indeed produce a much reduced amount of plutonium and MAs than conventional UO<sub>2</sub> fuels, **this is not the case for thorium-plutonium mixed fuel forms, and is less clear for thorium-LEU fuels.**

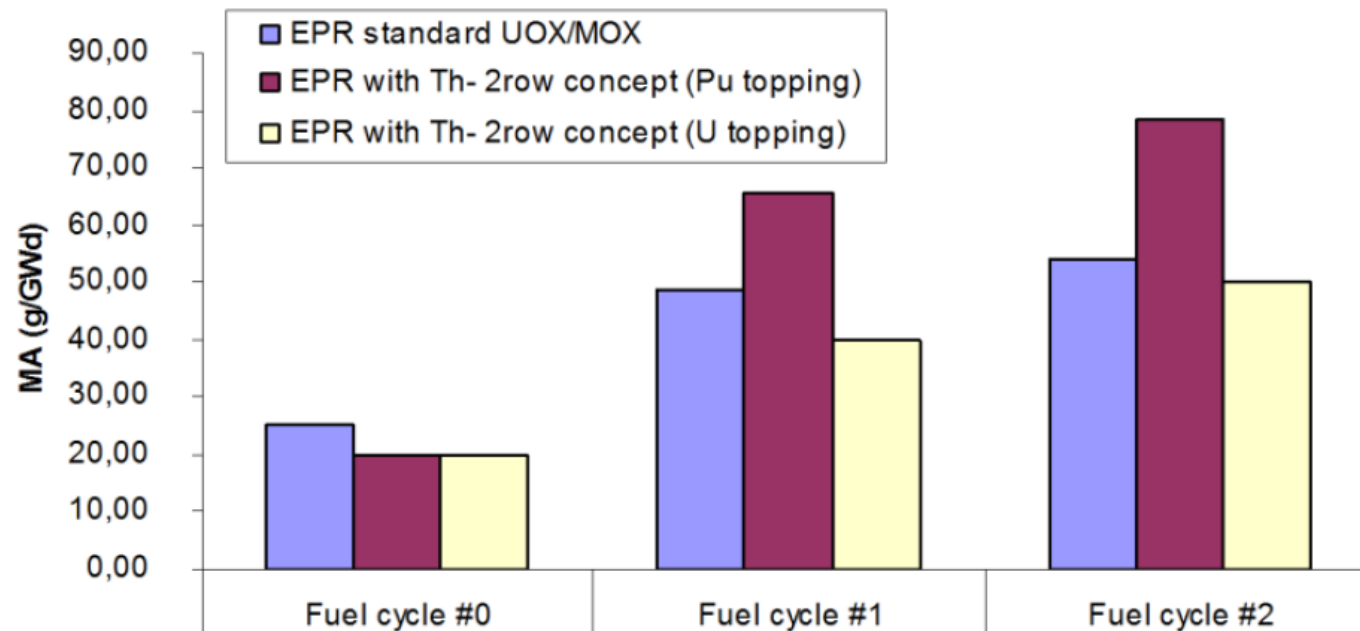

Taken from L. Van der Durpel

# Exercise Calculation: SF Ingestion Toxicity for Different PWR Fuel Types at the Same Discharge Burnup

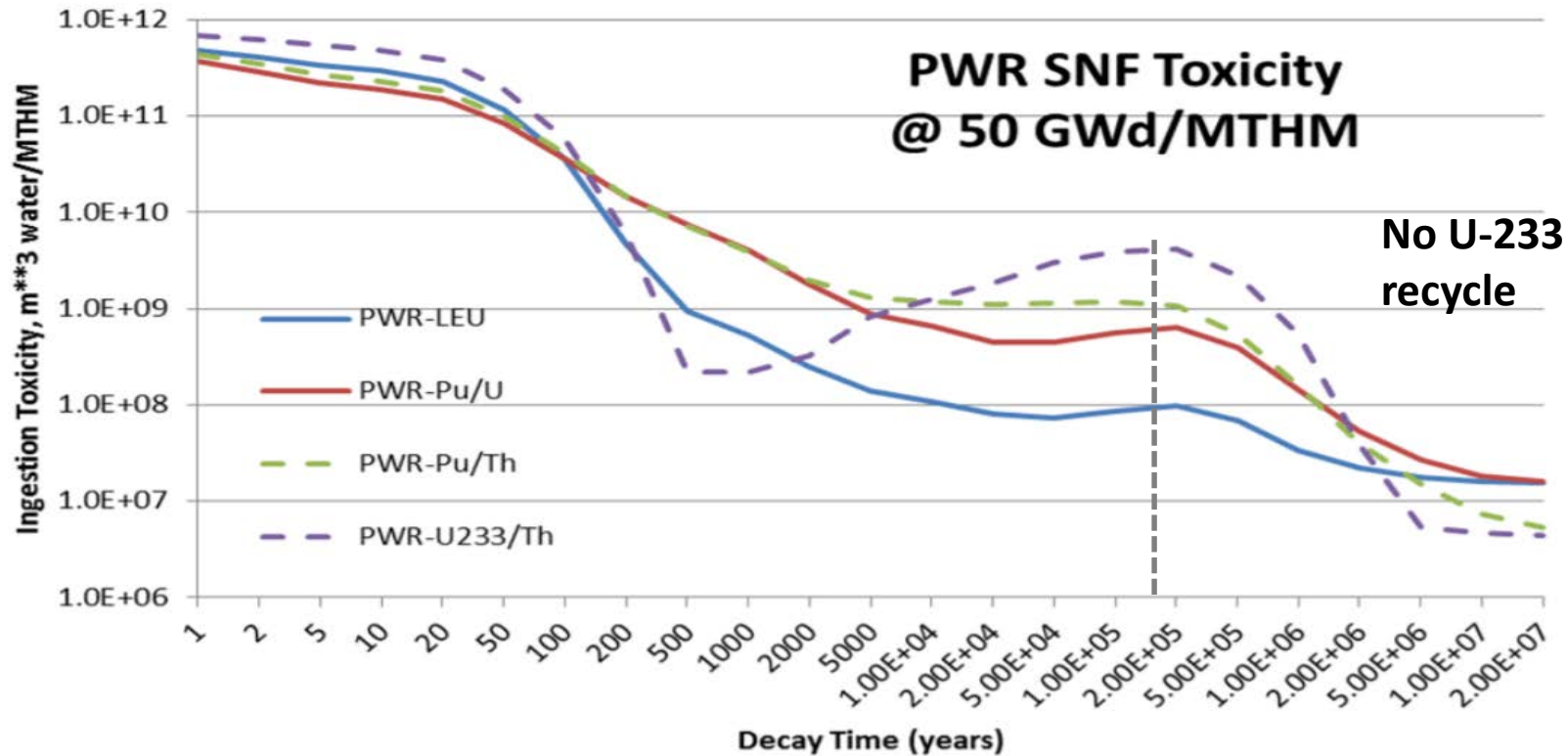

1. Ingestion toxicity, or ingested toxic potential, is a method of representing the hazard posed by radioactive waste. The International Commission for Radiological Protection (ICRP) has given recommended figures for the dose which would result from the ingestion of each radionuclide in an amount of radioactive waste. The method considers that the waste is dissolved in water and calculates how much water would be needed to dilute the waste to such an extent that someone could use the water for all his or her liquid intake in a year without exceeding the maximum permitted public dose of 1 millisievert. This is termed the ingested toxic potential of the waste.

Source: Croff and Krahn (2014).

## *Radiotoxicity of Th based fuel vs U fuel waste*

- Previous example (no U-233 recycle) : decay products from  $^{233}\text{U}$  (half-life = 160,000 years) drive radiotoxicity to be higher than that of LEU or U/Pu for the period between about ten thousand years and one million years:
- The relative differences between radiotoxicities resulting from the use of both cycles **vary greatly** depending on recycling strategies and recycling efficiencies considered and must therefore be **interpreted with caution.**
- The (very long) transition period using Th/U/Pu must be considered / integrated into the comparison!
- Unless clearly demonstrated, the long-term radiotoxicity of thorium-based spent nuclear fuels is therefore more accurately described as being comparable to that of uranium-based spent nuclear fuels.

# Thorium Fuel Reprocessing

Some of the same characteristics of  $\text{ThO}_2$  that would be considered an “advantage” for fuel behaviour pose a challenge for fuel reprocessing :

- High melting temperature
- Stable stoichiometric state (good for long term stability)
- High thermal conductivity

The more complex THOREX dissolution process requires combination of hydrofluoric and nitric acids and [has not been demonstrated at an industrial scale](#)

- THOREX experience domain is small scale recovery of  $^{233}\text{U}$  bred in  $\text{ThO}_2$  fuel
- Pyro-processing has only been used at laboratory scale only
- Basic data is still needed before demonstration of industrial scale maturity.



# Used Thorium Fuel Re-fabrication

Irradiated Thorium Fuel re-fabrication is severely complicated by presence of U-232 decay daughters with highly penetrating gammas

- U-232 abundance can be >1000 ppm (parts per million),
- Reprocessed Uranium (RU) fuel fabrication typically has U-232 < 0.01 ppm at which the radiological dose is already significant

Re-fabrication process is not viable in glove boxes – Remote operation and shielding is required (costly) – Such processes have not had any industrial demonstration

The **lack of industrially sound processes** for the reprocessing and re-fabrication of thorium fuels is a **significant impediment** to the implementation of the thorium fuel cycle.

# 1960/70's : Reactors have used Thorium based fuels

YEAR	Country	Reactor	Type	P (MWe)	Fuel Type	
1962	USA	IndianPoint1	PWR	275	Th/HEU-235	Mixed Oxide
<b>1964-1969</b>	<b>USA</b>	<b>MSRE</b>	<b>MSR</b>	<b>2-3</b>	<b>U-233 FLiBe</b>	<b>Molten salt</b>
1967-1974	USA	Peach Bottom	HTR	40	Th/HEU carbide	Microspheres
1976-1989	USA	Fort St Vrain	HTR	330	Th/HEU carbide	Microspheres
<b>1977-1982</b>	<b>USA</b>	<b>Shippingport</b>	<b>PWR</b>	<b>70</b>	<b>Th/U-233 ox</b>	<b>Seed/Blanket</b>
1983-1989	Germany	THTR	HTR	300	Th/HEU-235	Pebble – 90% U-235

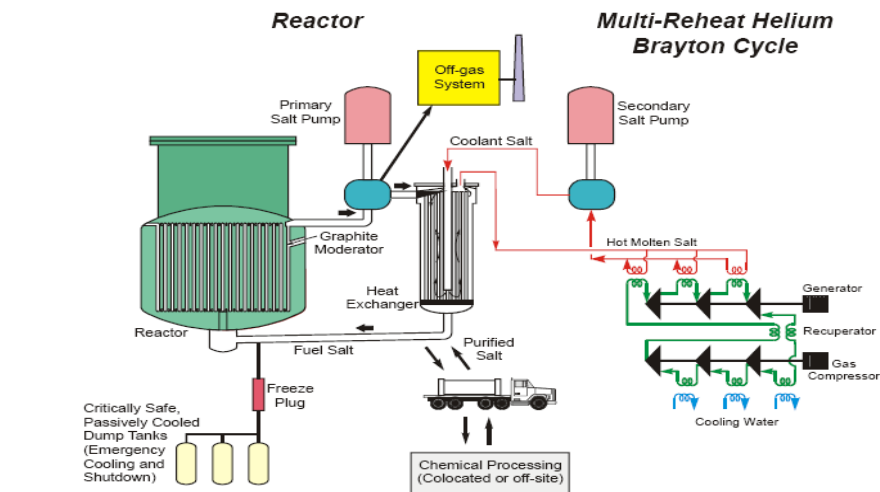
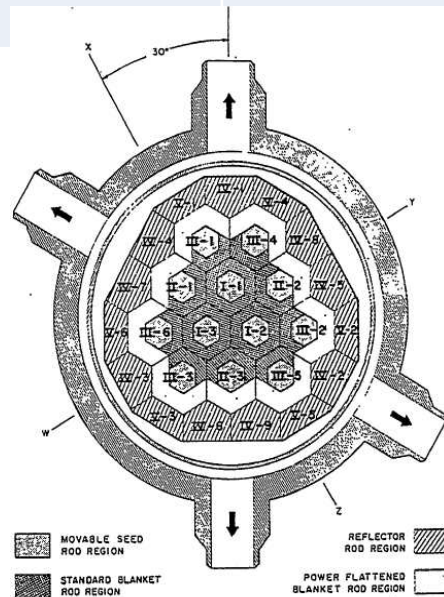

# A Thermal Breeder PWR with Th-U233

The very first commercial PWR for electricity production (60MWe, Shippingport Reactor, USA) was adapted to use Thorium fuel from 1977 to 1982, demonstrating breeding in the thermal spectrum

The Shippingport LWBR used a very complex geometry of  $\text{ThO}_2$ - $^{233}\text{UO}_2$  fuel zoning and  $\text{ThO}_2$  blanket assemblies

Post-irradiation analyses revealed an average of 1.4 % more fissile content in spent fuel than initially loaded. Breeding with slow neutrons was proven. It was also proven to be extremely complicated

Ref : INEEL/EXT-98-00799 (2002)

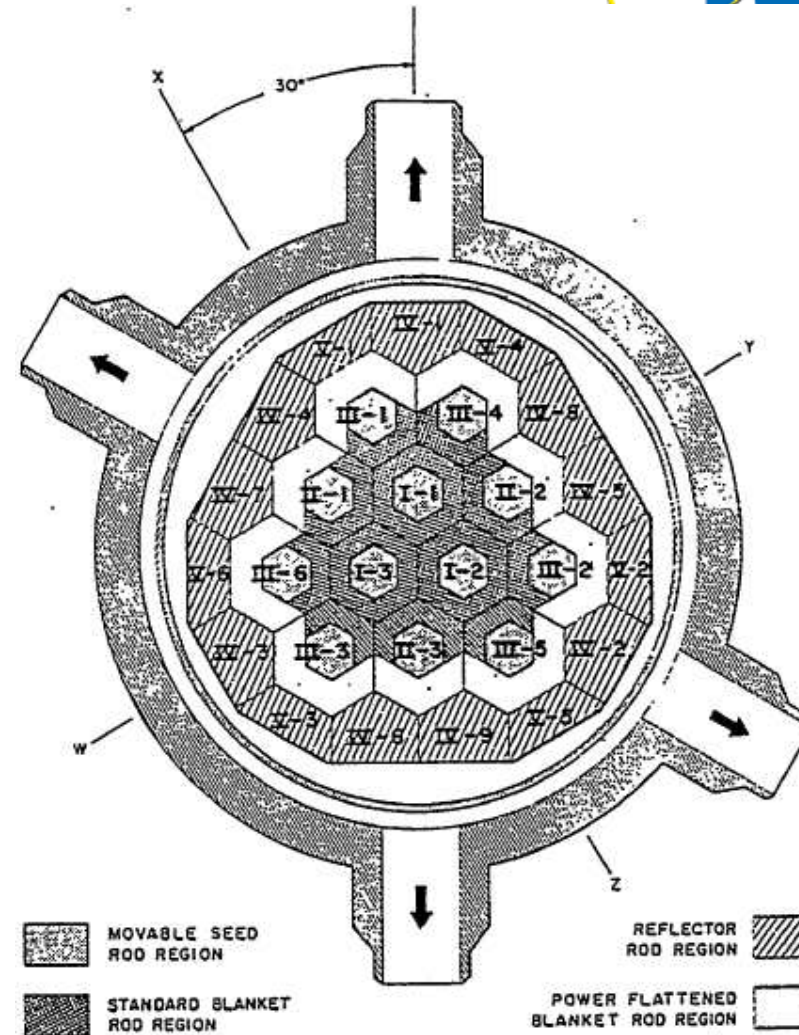

Shippingport's LWBR core

# MSBR Th/U233 Thermal Breeder (project) USA 1960-70's

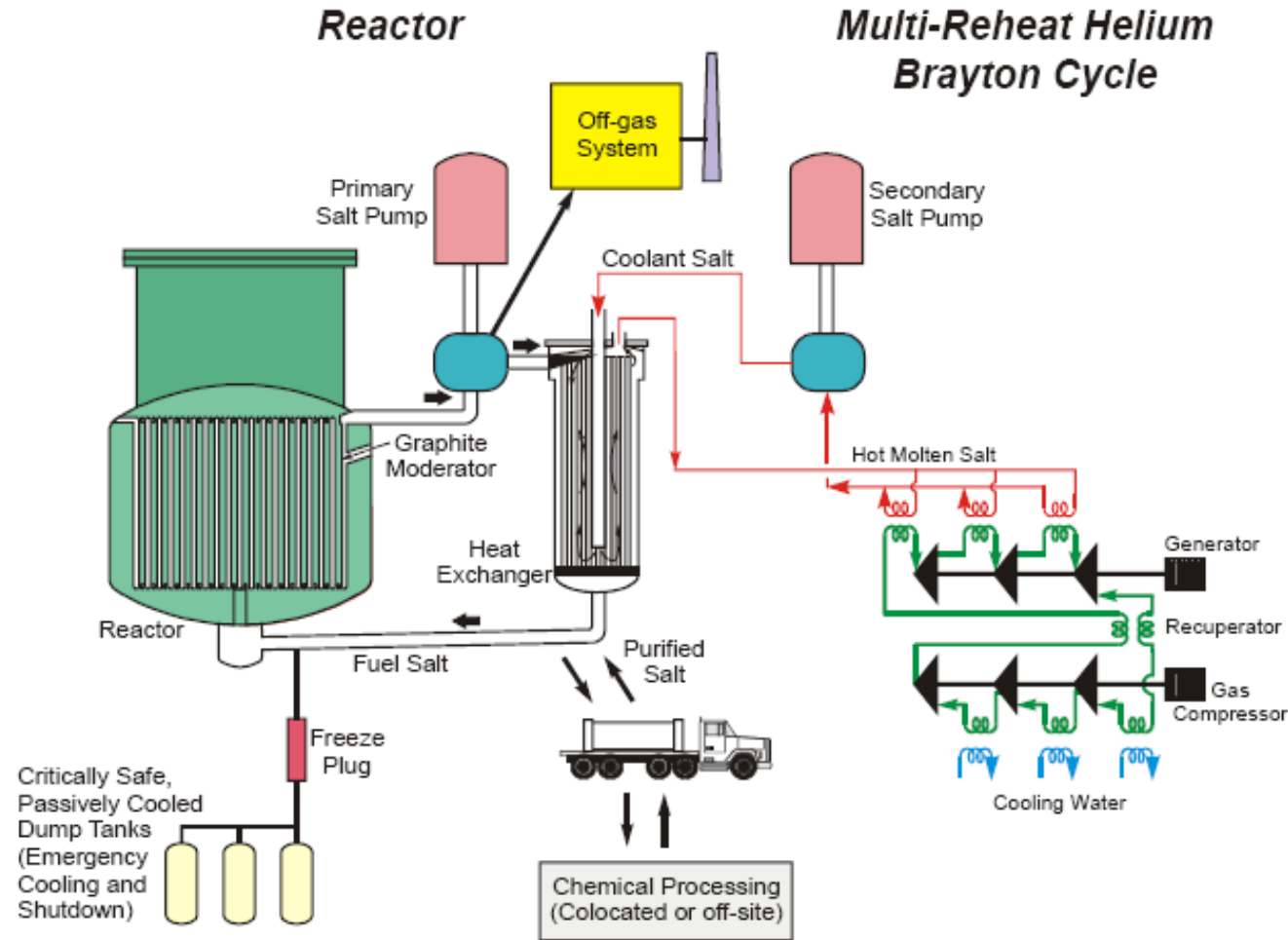

# Historical Thorium MSR Studies in France (CNRS)

## Thermal Spectrum Configurations

- Positive feedback coefficient
- Iso-breeder
- Long graphite life span
- Low  $^{233}\text{U}$  initial inventory

## Epithermal Spectrum Configurations

- Negative feedback coefficient
- Iso-breeder
- (Very) short graphite life span
- Low  $^{233}\text{U}$  initial inventory

## Fast Spectrum Configurations (no moderator)

- Strongly Negative feedback coefficient
- Breeder
- (no graphite)
- Large  $^{233}\text{U}$  initial inventory

MSFR reference concept studied in GIF, considers Th-LiF based salts with  $^{233}\text{U}$ , LEU and MOX initial fuel options

Taken from:  
E. Merle GIF Series MSFR Webinar, May 2017, L. Mathieu Ph.D.

# “High Conversion” instead of Breeding

- Hardening neutron spectrum can result in higher conversion systems that improve use of fissile resources
- Concept behind Th-based fuels in slightly modified, tighter fuel lattices in HWRs such as modified CANDUs or BWRs are under study

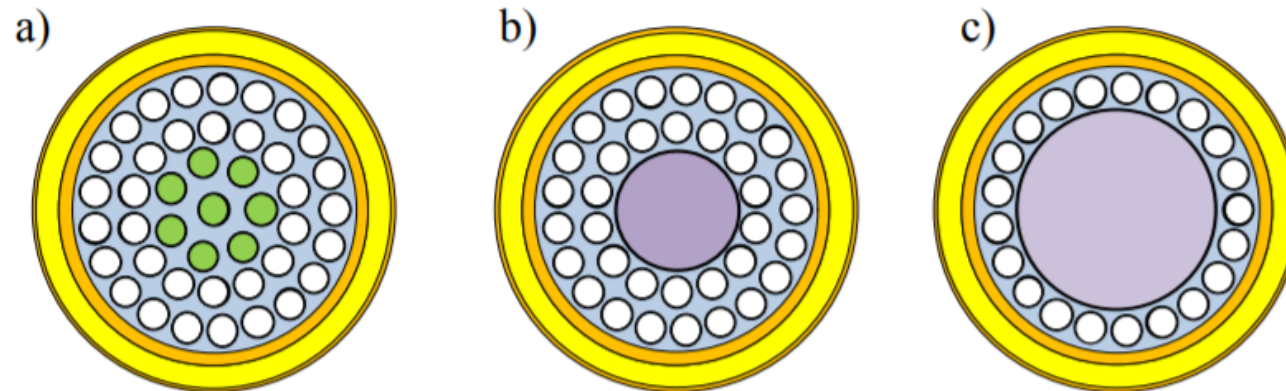

a) 43-element bundle with 8 ThO<sub>2</sub> elements in central region; b) 35-element bundle with central zircaloy-4 tube filled with ZrO<sub>2</sub> or D<sub>2</sub>O coolant; c) 21-element bundle with central zircaloy-4 tube filled with ZrO<sub>2</sub> or D<sub>2</sub>O coolant.

Source: Bromley (2014).

# Once-through versus Recycle

- *High converter* systems have a reduced fissile requirement (i.e. fewer tonnes of uranium per GWye)
  - Step towards sustainability,
  - Once-through fuel cycle
- *Breeder* systems can eventually get to a self-sustaining mode of operation with zero fissile requirement:
  - Equilibrium fuel cycle requiring only fertile input
  - **Achievable only after a long transition period** requiring neutrons from another fissile material (LEU or Pu)
  - Requires closed fuel cycle with spent fuel recycle and fuel re-fabrication

# Implementation of a Thorium Fuel Cycle : An inherently *long* transition process

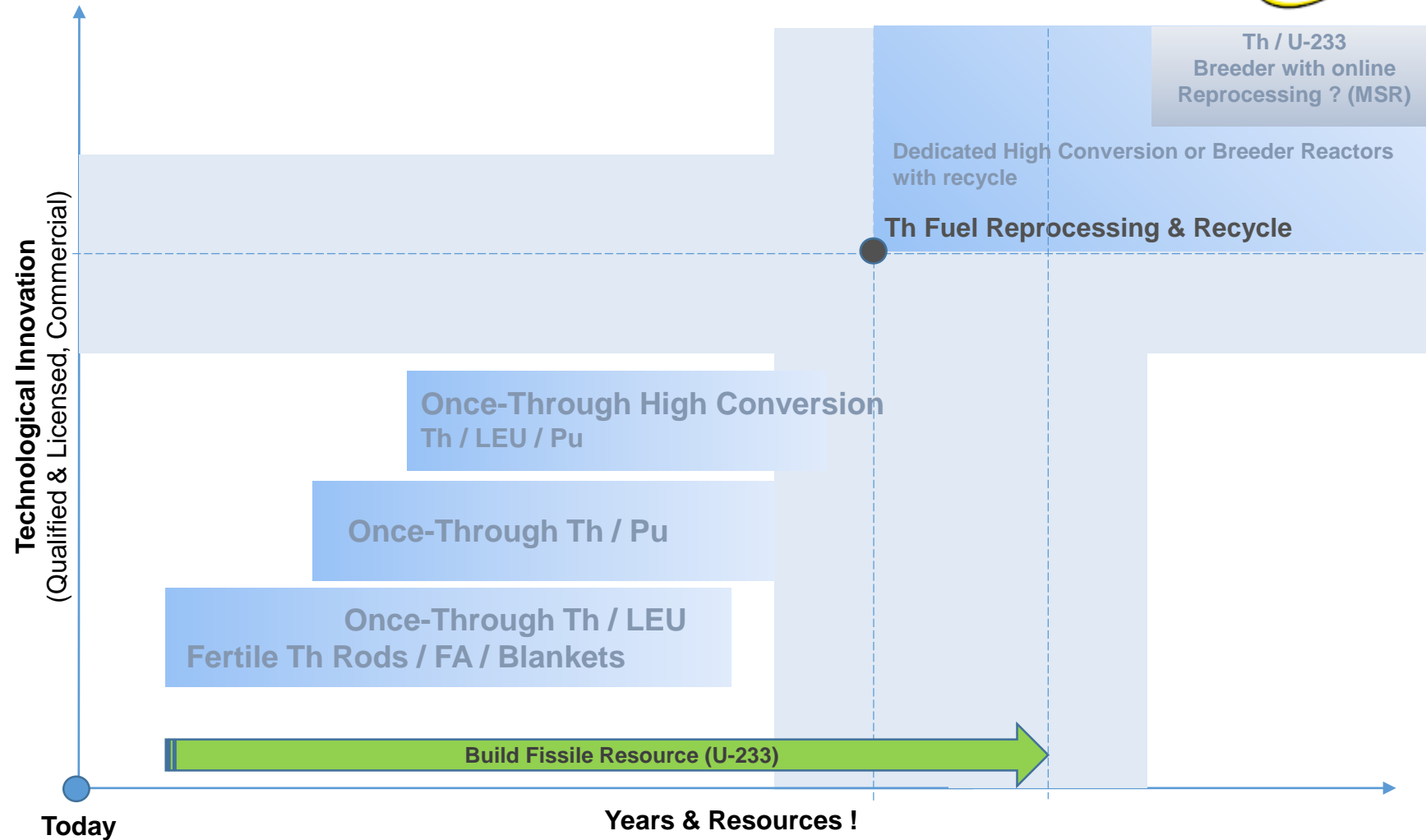



# Implementation of a Thorium Fuel Cycle : An inherently long transition process

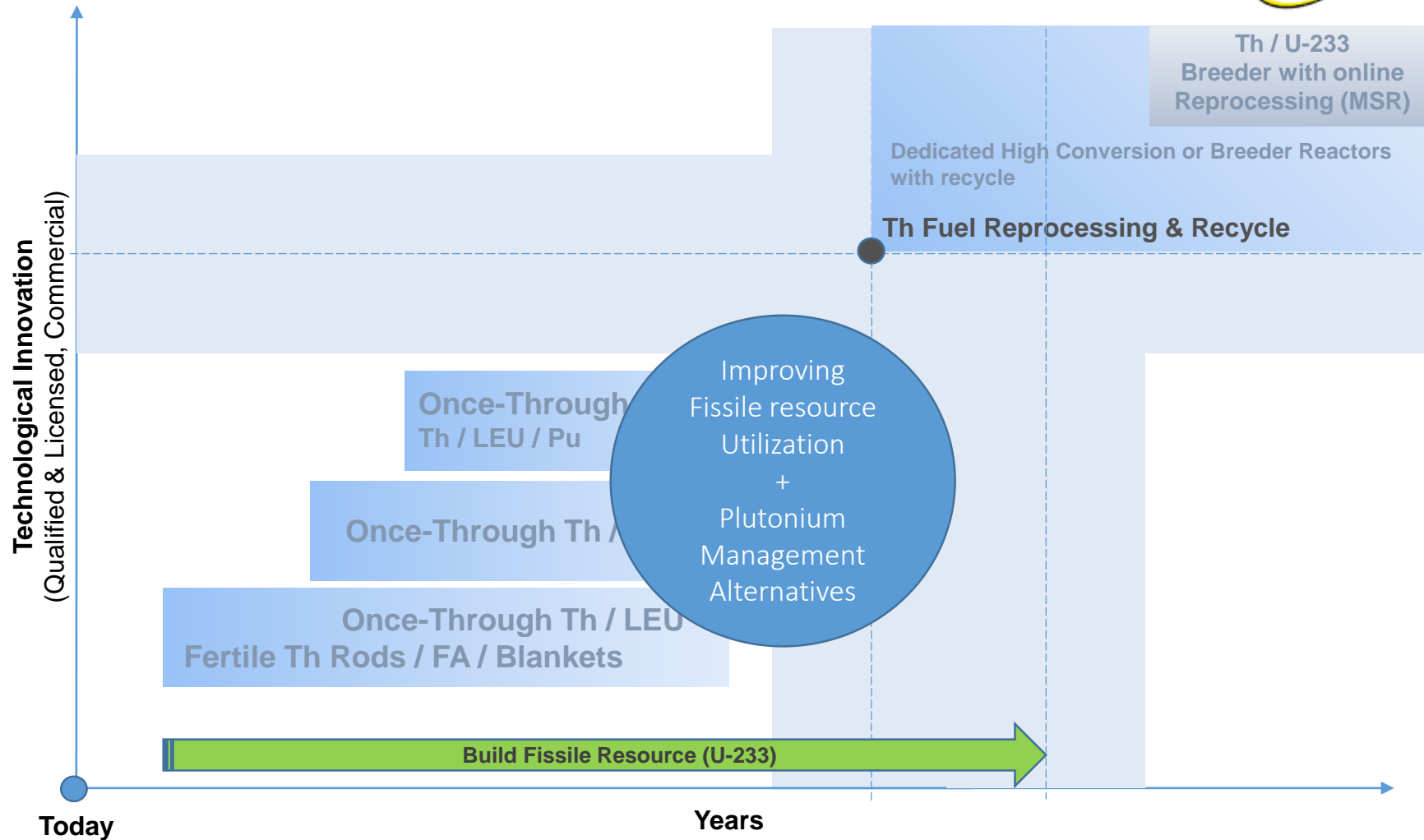

# Thorium FC: an inherently *long* transition process

## As illustrated by the Indian Strategy

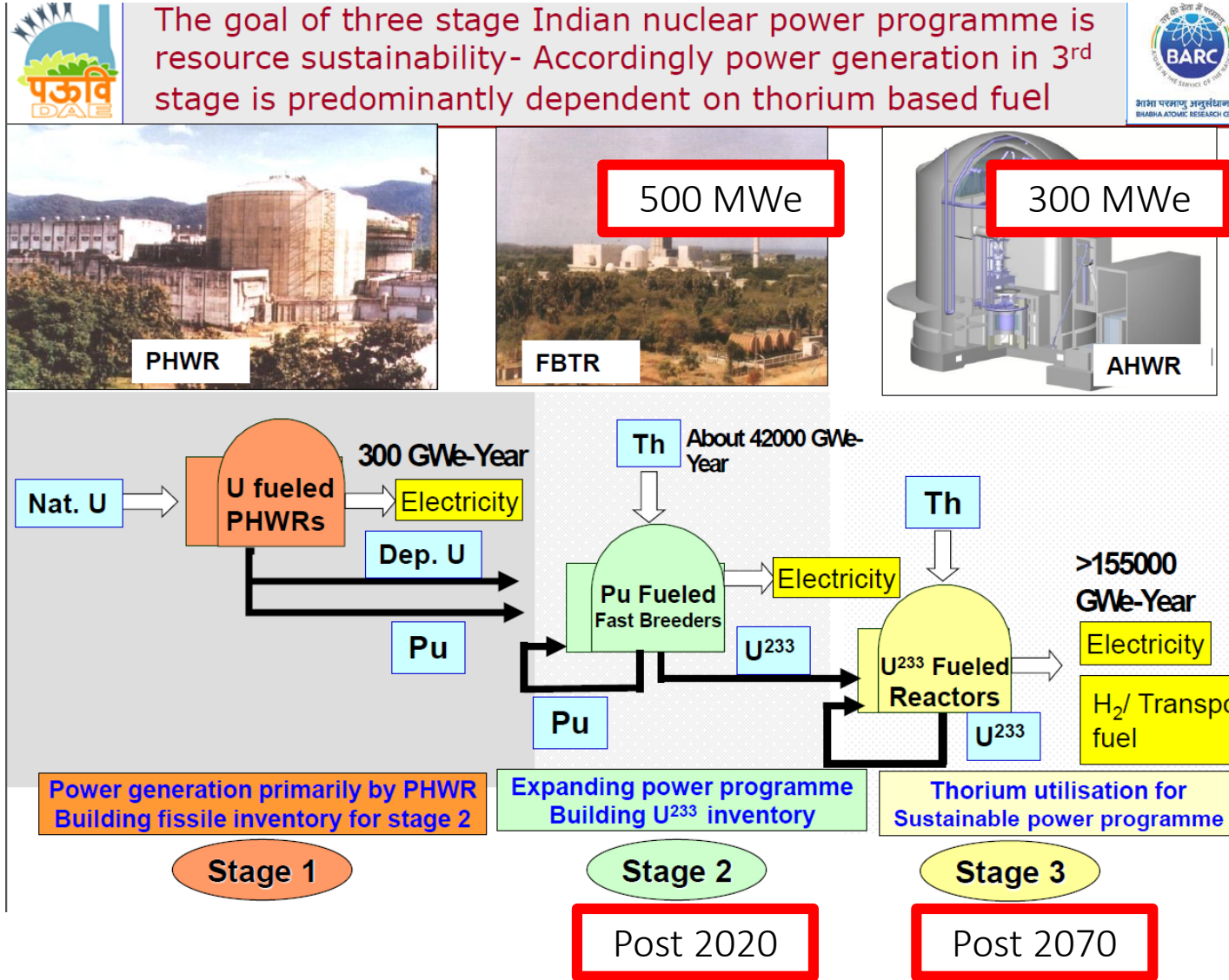



June 2017 : Russia to build another 2 new VVERs (LWRS)  
in Kudankulam, India

# Expectations for future Decommissioning Projects

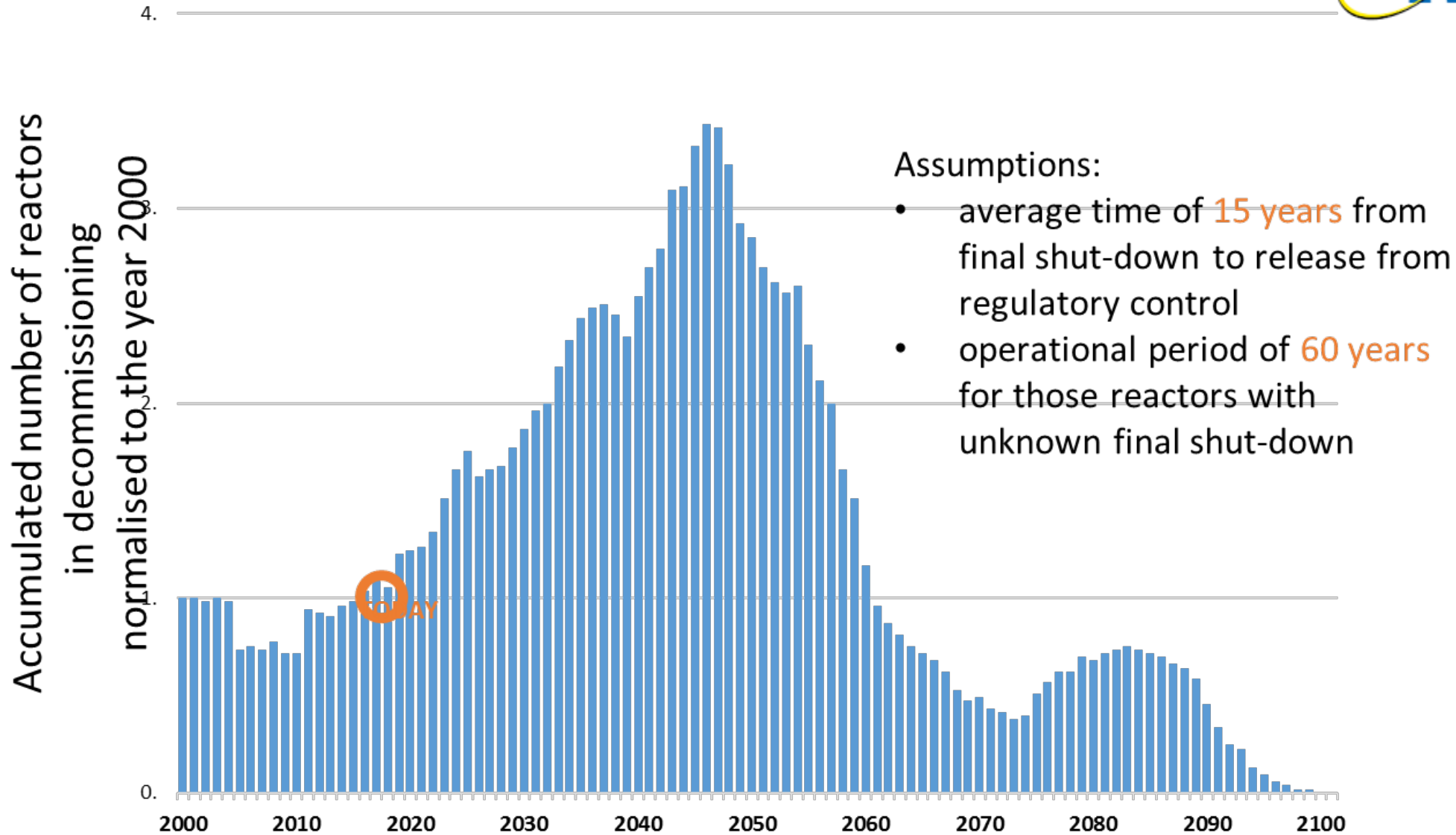

# “Energy Mix” will have to be the answer to climate challenges

## Policy sets the course for the power mix ...

Global electricity generation by fuel & scenario

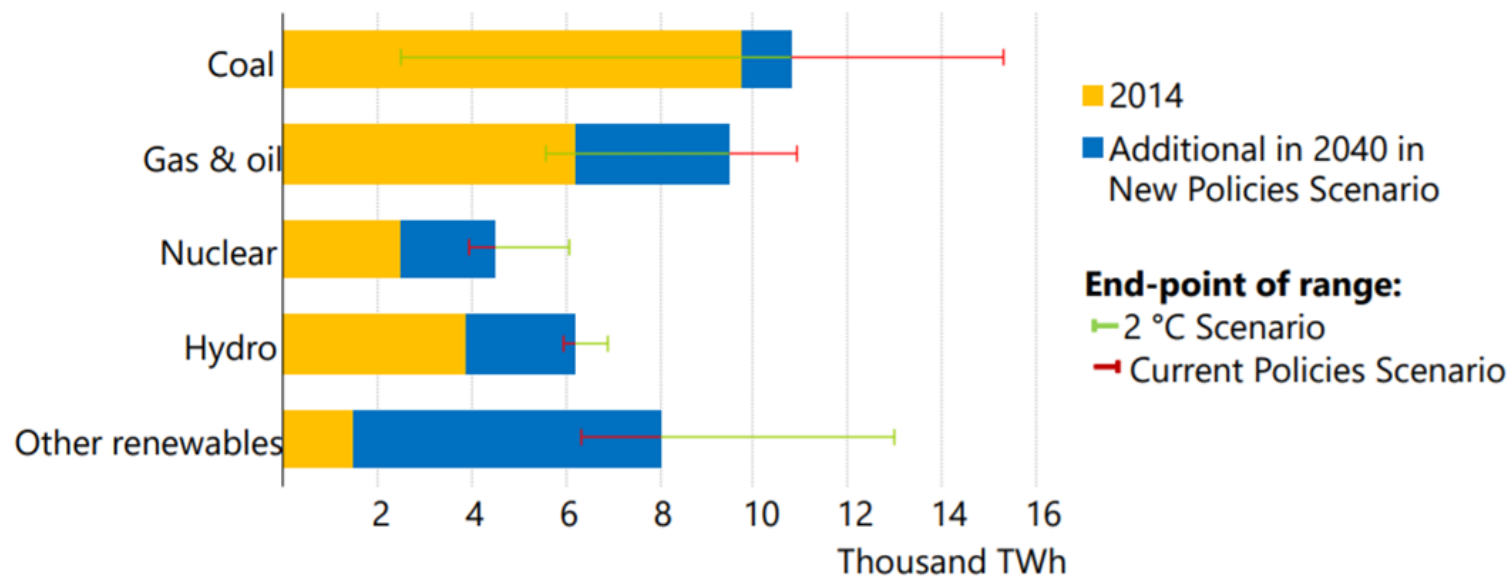

# Resource availability of Thorium

## Difficult to compare uranium and thorium resources

- Categories of **uranium resources depend on uranium extraction price** and therefore on the uranium market. There is **no standard classification for thorium resources**, no indexed thorium market, no thorium spot price.
- Historically, thorium has not been as prospected as uranium; Current knowledge is incomplete. Nevertheless, it is safe to assume that exploitable uranium and thorium mineral resources are of the **same order of magnitude : several million tonnes**.
- Keep in mind “the resource” is of different nature: **uranium is mined to retrieve 0.7% fissile uranium !** Thorium would have much **smaller (~100 times) mining requirements**.

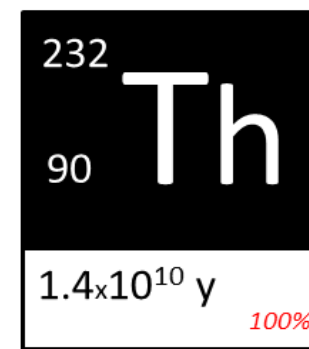
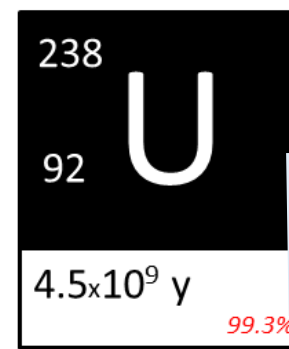
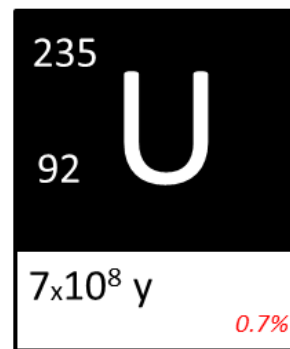

# Resource availability of Thorium

**Limited (non-nuclear) thorium market : Few incentives exist to open *new* mines with thorium as primary product :**

- Near-future thorium recovery will utilise **pre-existing mining operations** which **currently surface thorium but route it to waste** because of the small demand.
- **By-product production of thorium from other industrial mining activities can provide more than ample quantities of thorium for potential use in the nuclear industry for this century and beyond :**
  - Rare Earth ore mining
  - Ilmenite (titanium ore) mining
  - Iron ore mining

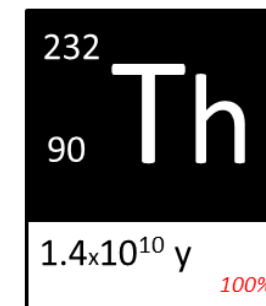
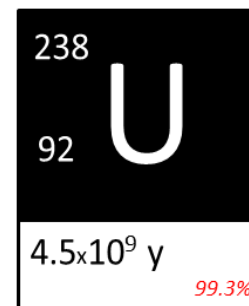
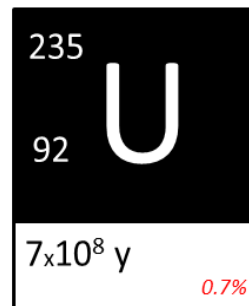

# Resource availability of Thorium

## *By-product production of Thorium*

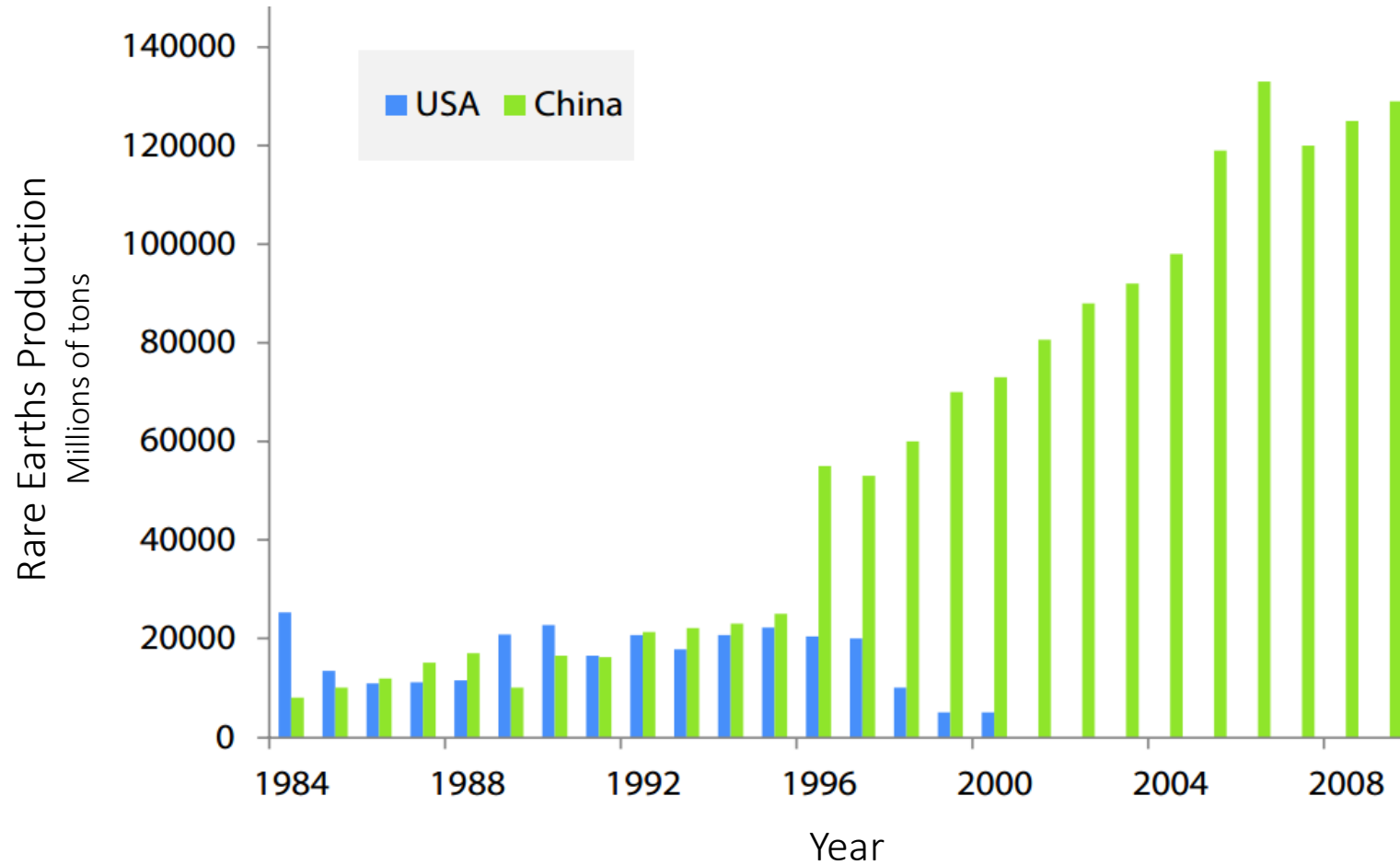

Source : Mancheri, Sundaresan, Chandrashekar, National Institute of Advanced Studies (India) Report R19-2013, ISBN 978-81-87663-84-3  
Data from USGS and British Geological Survey



# Resource availability of Uranium

“Regardless of the role that nuclear energy ultimately plays in meeting future electricity demand, **the uranium resource base is more than adequate to meet projected requirements** for the foreseeable future” – IAEA/NEA 2014 “Red Book”

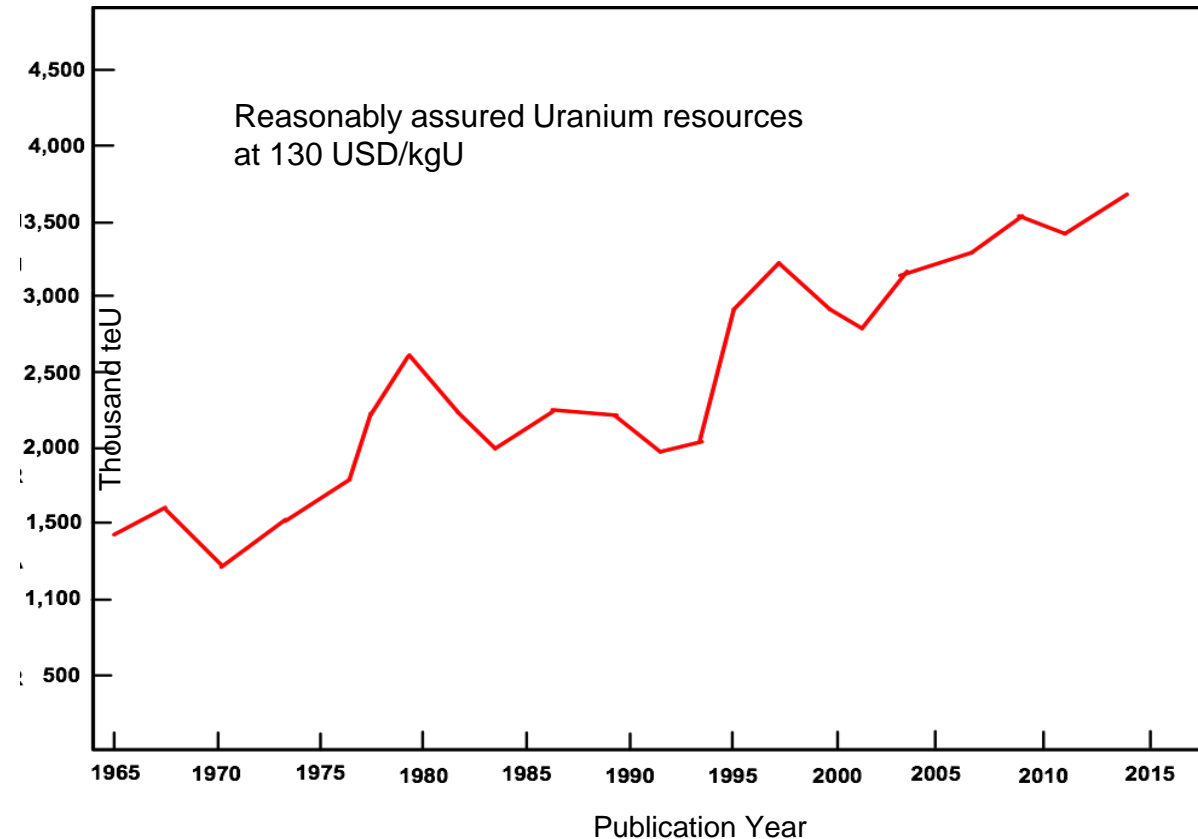

\* Compiled from IAEA/NEA Uranium Production and Demand “Red Books” (1966-2014).

# Conclusions

# The “Thorium question” is a very complex question

- Th-U233 : Long-term, if ever.
- Getting there ? Thorium-based fuels for:
  - Which system (Thermal ? Fast? LWRs, HWRs, BWRs, MSR, etc..)
  - Which Fuel form (Solid? Oxide?  $\text{ThO}_2$ ,  $\text{Th}(\text{LEU})\text{O}_2$ ,  $\text{ThPuO}_2$  ?  $\text{Th}(\text{U}, \text{Pu})\text{O}_2$  ? Liquid? Molten Salt? (FLiBe, FLiNaK ... )
  - Which Fuel management strategy (Once through? Recycle? Online reprocessing?)
  - In which deployment scenario ? National / Global ?
  - Under which drivers and for which objectives ?
    - Resource utilization
    - Safety
    - Non-proliferation
    - Waste ?

# The Thorium Fuel Cycle

- Based on  $^{233}\text{U}$ , a non-existing fissile nuclide (which can be bred, if Th first used with other fissile)
- Neutronically interesting,
- Chemically complex
- Technologically and industrially yet unsound
- Economically uncertain

# Is the “Thorium question” the wrong question?

- Failure to look at the complete picture, enumerating latent advantages or disadvantages of the use of thorium as a general resource for nuclear energy is misleading.
- *One does not retrieve energy from a mineral resource : **One retrieves energy from an industrial technology** (i.e. economically competitive)*
- To meet climate challenges at the scale needed, Nuclear Industry needs to provide flexible and well financed industrial strategies to deploy its solutions in the appropriate time-scales (i.e. before 2050)
- Can Thorium play a part in the answers Nuclear Industry needs to provide?

# “Competition” from Gen-IV systems LT Strategies will need to consider

Uncertainty around  
Readiness of Technology

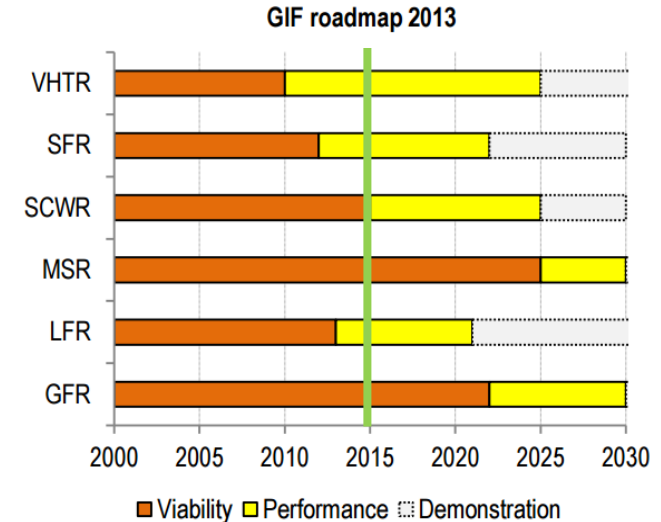
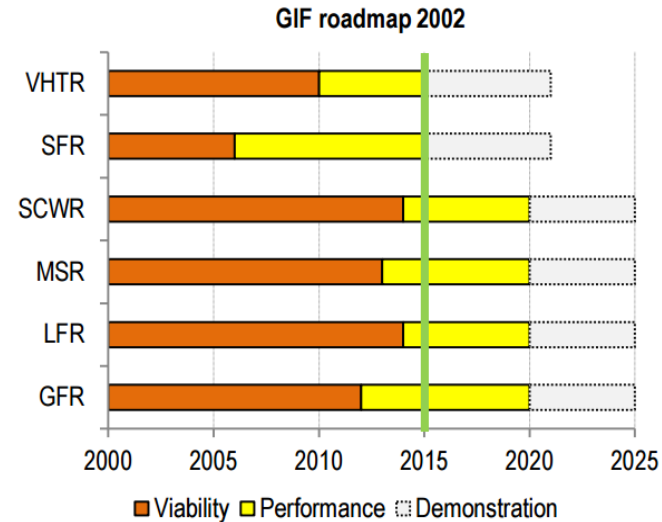

Source : Generation IV International Forum – Technology Roadmap Update (2013)

Uncertainty around  
Fissile inventory needs  
for deployment

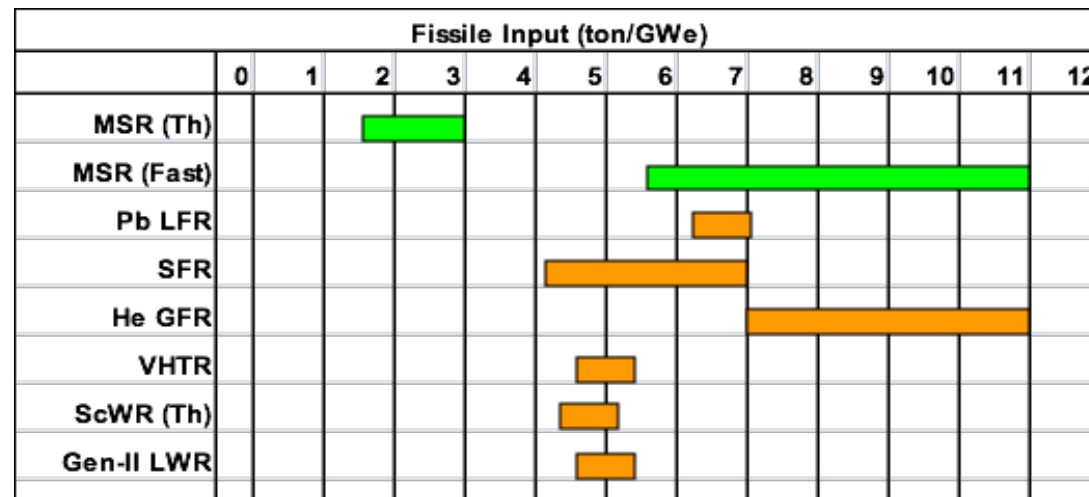

1,2,...3, 3+,...4

*There is no "skipping" a generation*

- The introduction of thorium into nuclear energy systems, if it occurs, will need to happen progressively.
- None of the scenarios envisaging a full transition towards a “100%” thorium/<sup>233</sup>U fuel cycle in the near or medium term are realistic, both for scientific and for industrial reasons.
- Any industrial application of thorium as a nuclear fuel would continue to require the input of fissile material from the existing uranium/plutonium cycle until the required amounts of <sup>233</sup>U could be produced and ultimately make the thorium cycle self-sustaining.
- The limitations imposed by fissile plutonium availability already point to rather long transition periods between thorium/plutonium and Th/<sup>233</sup>U systems, which are likely to be of the order of many decades, and still depend on finding the proper drivers to enable such a transition : Pu is needed for FBR !

## Concluding remarks (1/3)



- With uncertainties around large scale deployment of FR and the lack of geological repositories, alternate plutonium management strategies arise as valuable options
  - Where national conditions allow for it, a full deployment of fast breeder reactors using the U/Pu cycle will make the use of thorium hardly competitive
- The introduction of thoria-based fuels can represent a credible option for Plutonium management solution for the existing technological platform while also providing potential better utilization of fissile resources in High Conversion systems
- Thorium can play a role in enhancing the **flexibility** of future nuclear energy systems through symbiotic scenarios
  - Very significant R&D is still needed
  - Short-term economic incentives need to be identified



## Concluding remarks (2/3)

- With the lack of clear short-term economic incentives and no change in preferred future strategies, the present industrial development of thorium is likely to remain very limited
- Thorium is clearly no “silver bullet”
- *But Utilities are not looking for silver bullets, they are looking for options. Options have value in an uncertain context.*
- The thorium option should be kept open insofar it represents an interesting **complement** to the uranium FC to **strengthen** the sustainability of nuclear energy in the medium to long-term.

## Concluding remarks (3/3)

- Thorium can complement the uranium/plutonium fuel cycle
  - Valuable option for improved flexibility in the medium term and for full sustainability in the longer term
  - Some advantageous properties as a fuel matrix
- Full recycle requires THOREX reprocessing and remote fuel fabrication, both unproven
- Transition phase necessarily very long (many decades)
- Significant development required and no clear economic incentive for fuel vendors or utilities to invest at present
  - But strong case for short to medium term development of thorium fuels in incremental steps using existing U-Pu infrastructure
- Closed U-233/Th cycle best realized in Gen IV systems, especially MSR, but viable only on a long timescale

# *Admiral H. G. Rickover*

## *Address to U.S. Congress, June 1953*



*“Important decisions about the future development of atomic power must frequently be made by people who do not necessarily have an intimate knowledge of the technical aspects of reactors.*

*These people are, nonetheless, interested in what a reactor plant will do, how much it will cost, how long it will take to build and how long and how well it will operate. When they attempt to learn these things, there appears to be unresolved conflict on almost every issue that arises.*

*I believe that this confusion stems from a **failure to distinguish between the academic and the practical**”*

*Admiral H. G. Rickover*  
*Address to U.S. Congress, June 1953*

*“An **academic reactor** almost always has the following basic characteristics :*

- It is simple*
- It is small*
- It is cheap*
- It is light*
- It can be built very quickly*
- It is very flexible in purpose*
- Very little development is required*
- The reactor is in the study phase : it is not being built now.”*

*Admiral H. G. Rickover  
Address to U.S. Congress, June 1953*

*“A practical reactor, on the other hand*

- *Is being built now*
- *It is behind schedule*
- *It is requiring an immense amount of development on apparently trivial items. Corrosion, in particular, is a problem.*
- *It is very expensive*
- *It takes a long time to build because of engineering problems*
- *It is large*
- *It is heavy*
- *It is complicated.”*

*“It is worthwhile to bear in mind this distinction and to be guided thereby”*



EPR  
Flamanville  
Construction  
site



# NEA Reports on Thorium

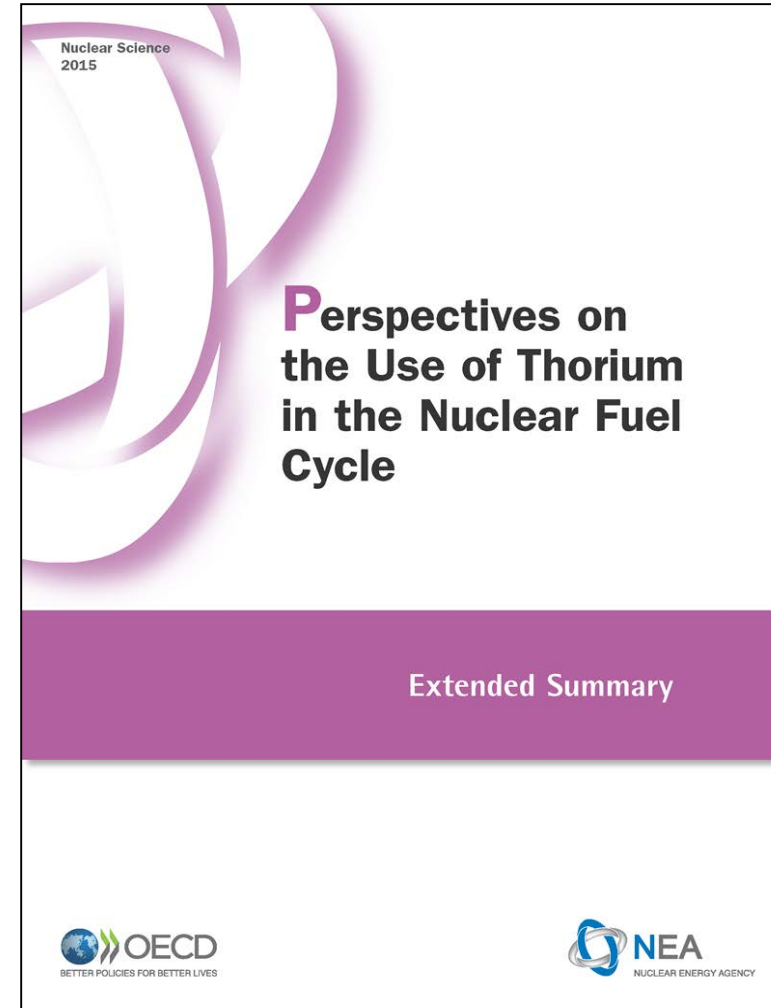
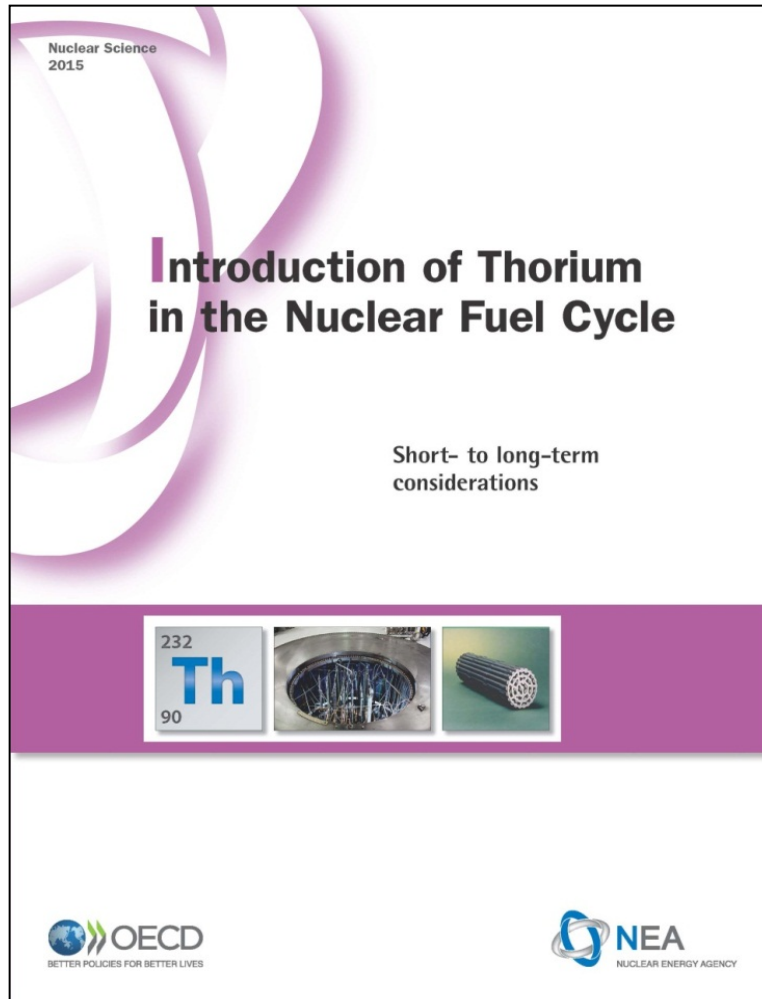

Online at [www.oecd-nea.org](http://www.oecd-nea.org)

## Some Other (Recent) Studies

- 2014 - *USNRC* – *Safety and Regulatory Issues of the Thorium Fuel Cycle*
- 2012 - *IAEA* – *Role of Thorium to Supplement Fuel Cycles of Future Nuclear Energy Systems*
- 2011 – *OECD NEA* – “*Trends towards sustainability in the Nuclear Fuel Cycle*”
- 2011 - *UK National Nuclear Laboratory* Position Paper “*The Thorium Fuel Cycle*”
- 2011 - *SNETP* – *Thorium Cycles and Thorium as Nuclear Fuel Component – SRA Annex*
- 2010 - *Generation IV International Forum*- *Position of GIF - Internal Note on Thorium*
- 2008 - *Norway* “*Thorium as an Energy Source*”
- 2005 - *IAEA* – *Thorium Fuel Cycle – Potential Benefits and Challenges*

To find out more



[www.oecd-nea.org](http://www.oecd-nea.org)



Thank you for your attention

[Franco.Michel-Sendis@oecd.org](mailto:Franco.Michel-Sendis@oecd.org)



# Upcoming webinars

August 22, 2017

Metallic Fuel for SFRs, Dr. Steven Hayes

Idaho National Laboratory,  
USA

September 21, 2017

Energy Conversion, Dr. Richard Stainsby

NNL, UK

October 25, 2017

Economics of the Nuclear Fuel Cycle,  
Dr. Geoffrey Rothwell

OECD/NEA